

FE e-Front runners

High Performance Compact Inverters
FRENIC-Multi Series

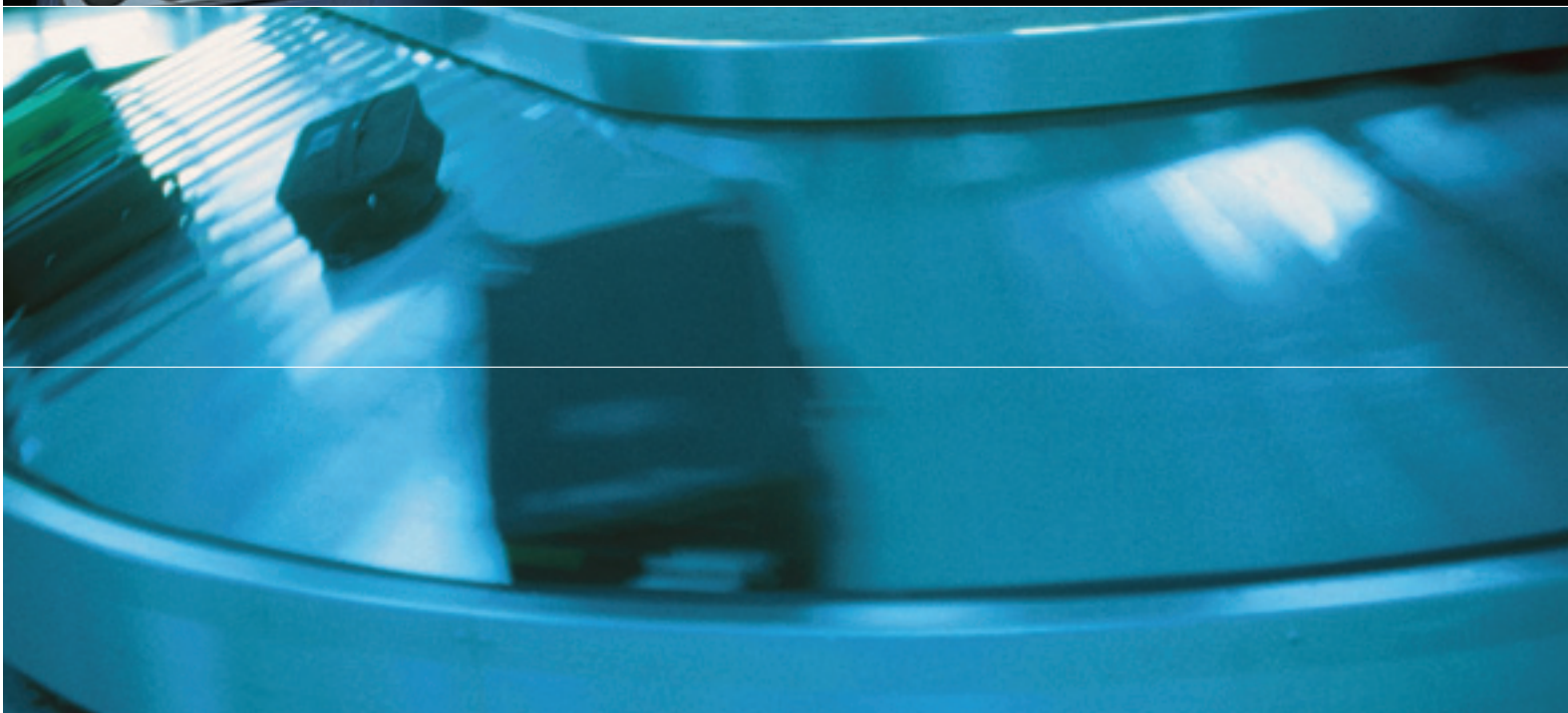

FUJI INVERTERS

HIGH PERFORMANCE THROUGH COMPACT DEDICATED DESIGNS
WELCOME TO A NEW GENERATION OF MULTIPUSE INVERTERS



UL US LISTED



MEH531

With advanced technology built in, these new



Gentler on the environment !

Complies with European regulations that limit the use of specific hazardous substances (RoHS).

These inverters are gentle on the environment. Use of 6 hazardous substances is limited. (except for interior soldering in the power module.)

<Six Hazardous Substances>

Lead, Mercury, Cadmium, Hexavalent Chromium, Polybrominated biphenyl (PBB), Polybrominated diphenyl ether (PBDE)

<About RoHS>

The Directive 2002/95/EC, promulgated by the European Parliament and European Council, limits the use of specific hazardous substances included in electrical and electronic devices.



Long-life design!

The design life of each internal component with limited life has been extended to 10 years. This helps to extend the maintenance cycle for your equipment.

Limited Life Component	Service Life
Main circuit capacitors	10 years
Electrolytic capacitors on the printed circuit board	10 years
Cooling fan	10 years

Conditions: Ambient temperature is 40°C(104°F) and load factor is 80% of the inverter's rated current.

Noise is reduced by the built-in EMC filter.

Use of a built-in EMC filter that reduces noise generated by the inverter makes it possible to reduce the effect on peripheral equipment.



Expanded capacity range and abundant model variation !

●Standard Series

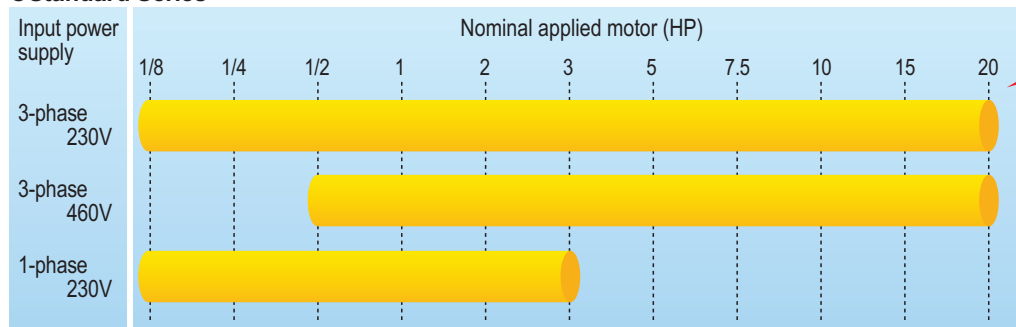

Capacity expanded to 20HP

●Semi-Standard type

- EMC filter built-in type

●Option card

- PG interface card (5V type)(12V type)
- RS-485 communication card
- Synchronized operation card
- Device Net card
- Profibus-DP card
- DIO card
- CC-Link card



inverters can be used for multiple purposes!



The highest standards of control and performance in its class!

Specifications

External Dimensions

Keypad Operations

Basic Wiring Diagram

Terminal Functions

Protective Functions

Functions Settings

Peripheral Equipment Connection Diagrams

Options

Warranty

Shortened setting time in slip compensation control

Through "slip compensation control" + "voltage tuning," speed control accuracy at low speeds is improved. This minimizes variations in speed control accuracy at times when the load varies, and since the time at creep speeds is shortened, single cycle tact times can be shortened.

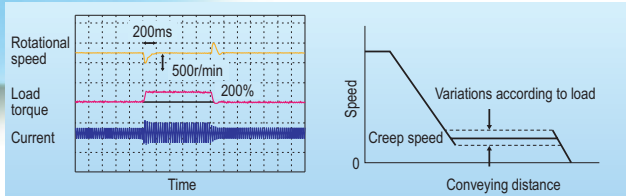

Equipped with the highest level CPU for its class!

The highest level CPU of any inverter is used. Computation and processing capacity is doubled over the previous inverter, improving speed control accuracy.

●CPU speed comparison

FVRE11S

32MHz

FRENIC-Multi

64MHz

FRENIC-Multi has doubled processing capacity compared with the previous model.

Compatible with PG feedback control

<Example of conveyor operation pattern>

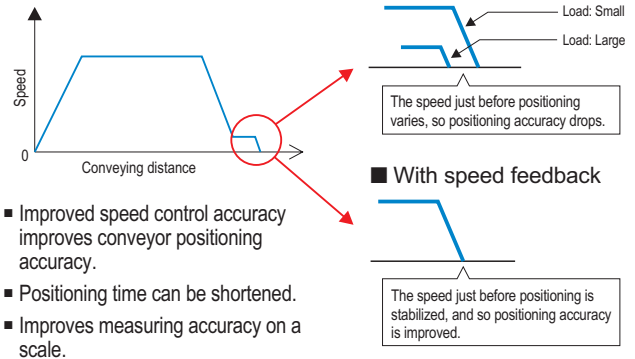

Tripless deceleration by automatic deceleration control

The inverter controls the energy level generated and the deceleration time, and so deceleration stop can be accomplished without tripping due to overvoltage.

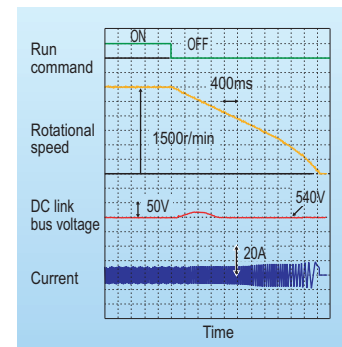

Optimum for the operations specific to vertical and horizontal conveyance!

Hit-and-stop control is realized more easily!

Impacts are detected mechanically and not only can the inverter's operation pattern be set on coast-to-stop or deceleration stop, but switching from torque limitation to current limitation and generating a holding torque (hit-and-stop control) can be selected, making it easy to adjust brake application and release timing.

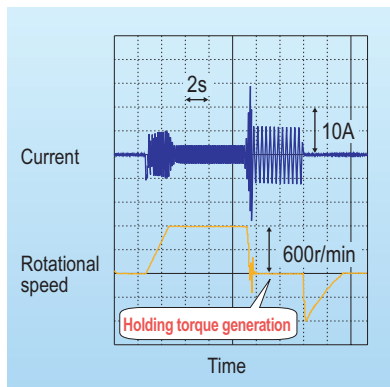

Inclusion of a brake signal makes it even more convenient.

- **At brake release time**
After the motor operates, torque generation is detected and signals are output.
- **At brake application time**
Brake application that matches the timing can be done, and so mechanical brake wear is reduced.

Limit operations can be selected to match your equipment!

Inverters are equipped with two limit operations, "torque limitation" and "current limitation," so either can be selected to match the equipment you are using the inverter with.

- **Torque limitation**
In order to protect mechanical systems, this function accurately limits the torque generated by the motor. (Instantaneous torque cannot be limited.)
- **Current limitation**
This function limits the current flowing to the motor to protect the motor thermally or to provide rough load limitation. (Instantaneous current cannot be limited. Auto tuning is not required.)



Simple and thorough maintenance !

The life information on each of the inverter's limited life components is displayed.



Simple cooling fan replacement!

Construction is simple, enabling quick removal of the top cover and making it easy to replace the cooling fan. (7.5HP or higher models)

Cooling fan replacement procedure



The cover on top of the inverter can be quickly removed.



Simply disconnect the power connector and replace the cooling fan.

Information that contributes to equipment maintenance is displayed!

In addition to inverter maintenance information, data that also take equipment maintenance into consideration are displayed.

Item	Purpose
Motor cumulative running time (hr)	The actual cumulative running time of the equipment (motor) the inverter is being used with is calculated. <Example of use> If the inverter is used to control a fan, this information is an indication of the timing for replacing the belt that is used on the pulleys.
Number of starts (times)	The number of times the inverter starts and stops can be counted. <Example of use> The number of equipment starts and stops is recorded, and so this information can be used as a guideline for parts replacement timing in equipment in which starting and stopping puts a heavy load on the machinery.

The alarm history records the latest four incidents.

Detailed information can be checked for the four most recent alarms.



Simple operation, simple connection !

A removable keypad is standard equipment.

The keypad can be easily removed and reset, making remote operation possible. If the back cover packed with the inverter is installed and a LAN cable is used, the keypad can be easily mounted on the equipment's control panel.



A removable interface card is adapted.

Wiring is quite easy because the interface card can be attached and detached as a terminal base for control signals.



The following option cards are available.

Option card names	Installation method
RS-485 communication card	Built in the inverter (replaced with the standard interface card)
PG interface card (for 5V)	Built in the inverter (replaced with the standard interface card)
PG interface card (for 12V)	Built in the inverter (replaced with the standard interface card)
CC-Link card	Front installation type
DeviceNet card	Front installation type
DIO card	Front installation type
SY (synchronized operation) card	Front installation type
PROFIBUS-DP card	Front installation type (Available soon)

Note) The inverter that can be used with the SY card includes special specifications. When ordering the SY card, please order together with the inverter in a set.

A multi-function keypad which enables a wide variety of operations is available.

A multi-function keypad is available as an option. This keypad features a large 7-segment LED with five digits and large back-lighted liquid crystal panel. Its view-ability is high, and guidance is displayed on the liquid crystal panel, therefore operations can be conducted simply. (A copy function is included.)



Inverter support loader software is available. (On sale soon)

Windows compatible loader software is available to simplify the setting and management of function codes.

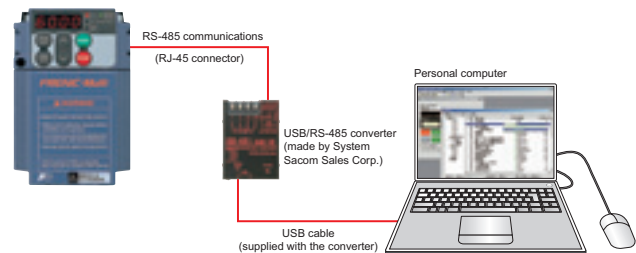

Simulated failure enables peripheral device operation checks.

The inverter has the function for outputting dummy alarm signals, enabling simple checking of sequence operations of peripheral devices from the control panel where the inverter is used.



Consideration of peripheral equipment, and a full range of protective functions!

Side-by-side mounting saves space!

If your control panel is designed to use multiple inverters, these inverters make it possible to save space through their horizontal side-by-side installation. (5HP or smaller models)



Resistors for suppressing inrush current are built in, making it possible to reduce the capacity of peripheral equipment.

When FRENIC-Multi Series (including FRENIC-Mini Series, FRENIC-Eco Series and 11 Series) is used, the built-in resistor suppresses the inrush current generated when the motor starts. Therefore, it is possible to select peripheral equipment with lower capacity when designing your system than the equipment needed for direct connection to the motor.

Outside panel cooling is also made possible using the mounting adapter for external cooling (option).

The mounting adapter for external cooling (option) can be installed easily as an outside panel cooling system.



You can use an inverter equipped with functions like these!

First time in the industry New system for more energy-efficient operation!

Previous energy saving operation functions worked only to control the motor's loss to keep it at a minimum in accordance with the load condition. In the newly developed FRENIC-Multi Series, the focus has been switched away from the motor alone to both the motor and the inverter as electrical products. As a result, we incorporated a new control system (optimum and minimum power control) that minimizes the power consumed by the inverter itself (inverter loss) and the loss of the motor.

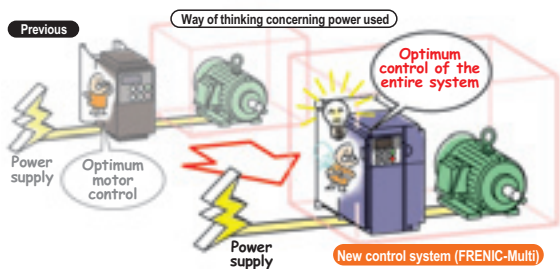

Operating signal trouble is avoided by the command loss detection function!

If frequency signals connected to the inverter (0 to 10V, 4 to 20mA, Multi-speed signals, communications, etc.) are interrupted, the missing frequency commands are detected as a "command loss." Further, the frequency that is output when command loss occurs can be set in advance, so operation can be continued even in cases where the frequency signal lines are cut due to mechanical vibrations of the equipment, etc.

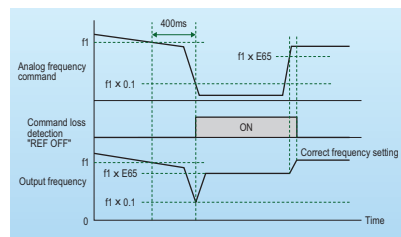

An overload stop function protects equipment from over-operation!

If the load on equipment suddenly becomes great while controlled by the inverter, the inverter can be switched to deceleration stop or to coast-to-stop operation to prevent damage to the equipment.

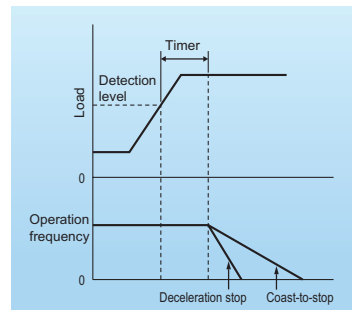

Smooth starts through the pick-up function!

In the case where a fan is not being run by the inverter but is turning free, the fan's speed is checked, regardless of its rotational direction, and operation of the fan is picked up to start the fan smoothly. This function is convenient in such cases as when switching instantaneously from commercial power supply to the inverter.

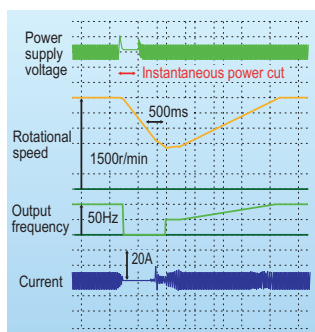

Equipped with a full range of PID control functions!

Differential alarm and absolute value alarm outputs have been added for PID adjusters which carry out process controls such as temperature, pressure and flow volume control. In addition, an anti-reset windup function to prevent PID control overshoot and other PID control functions which can be adjusted easily through PID output limiter, integral hold/reset signals are provided. The PID output limiter and integral hold/reset signals can also be used in cases where the inverter is used for dancer control.

Continuous equipment operation with overload avoidance control!

If foreign matter gets wrapped around a fan or pulley and the load increases, resulting in a sudden temperature rise in the inverter or an abnormal rise in the ambient temperature, etc. and the inverter becomes overloaded, it reduces the motor's speed, reducing the load and continuing operation.

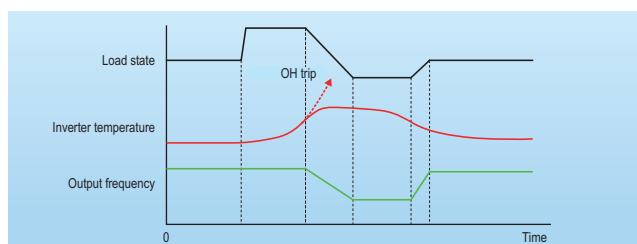



Fully compatible with network operation!

RS-485 communications (connector) is standard!

A connector (RJ-45) that is compatible with RS-485 communications is standard equipment (1 port, also used for keypad communications), so the inverter can be connected easily using a LAN cable (10BASE).



RJ-45 Connector

Wiring is easy with the RS-485 communications card (optional)!

The RS-485 communications card is also available as an option. When it is installed, you can add a branch connection that is separate from the communications port provided as standard equipment (RJ-45 connector), and have two communications ports.

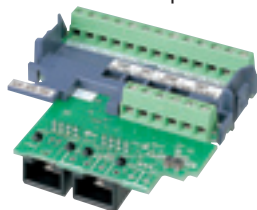

■ Important Points

- (1) A separate branch adaptor is not required because of two ports.
- (2) The built-in terminating resistor makes provision of a separate terminating resistor unnecessary.

■ Example of connection configuration with peripheral equipment

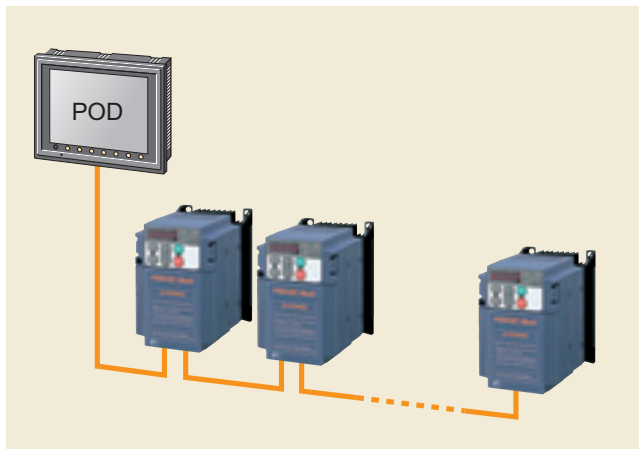

Complies with optional networks using option cards.

Installation of special interface cards (option) makes it possible to connect to the following networks.

- DeviceNet
- PROFIBUS-DP
- CC-Link



Global compatibility!

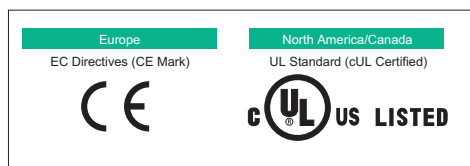

- Complies with standards
- Sink/Source switchable
- Wide voltage range
- The multi-function keypad displays multiple languages (Japanese, English, German, French, Spanish, Italian, Chinese, Korean).
 - * This product supports multiple languages such as Japanese, English, German, French, Spanish and Italian. Another multiple language version is also available, which supports Japanese, English, Chinese, Korean and simplified Chinese. (Contact us for the detail separately.)



Safety Precautions

1. Use the contents of this catalog only for selecting product types and models. When using a product, read the Instruction Manual beforehand to use the product correctly.
2. Products introduced in this catalog have not been designed or manufactured for such applications in a system or equipment that will affect human bodies or lives. Customers, who want to use the products introduced in this catalog for special systems or devices such as for atomic-energy control, aerospace use, medical use, and traffic control, are requested to consult the Fuji's Sales Division. Customers are requested to prepare safety measures when they apply the products introduced in this catalog to such systems or facilities that will affect human lives or cause severe damage to property if the products become faulty.

Model List

Applicable motor rating (HP)	Standard type			Semi-standard type EMC filter built-in type		
	Three-phase 230V	Three-phase 460V	Single-phase 230V	Three-phase 230V	Three-phase 460V	Single-phase 230V
1/8	FRNF12E1S-2U		FRNF12E1S-7U	FRNF12E1E-2U		FRNF12E1E-7U
1/4	FRNF25E1S-2U		FRNF25E1S-7U	FRNF25E1E-2U		FRNF25E1E-7U
1/2	FRNF50E1S-2U	FRNF50E1S-4U	FRNF50E1S-7U	FRNF50E1E-2U	FRNF50E1E-4U	FRNF50E1E-7U
1	FRN001E1S-2U	FRN001E1S-4U	FRN001E1S-7U	FRN001E1E-2U	FRN001E1E-4U	FRN001E1E-7U
2	FRN002E1S-2U	FRN002E1S-4U	FRN002E1S-7U	FRN002E1E-2U	FRN002E1E-4U	FRN002E1E-7U
3	FRN003E1S-2U	FRN003E1S-4U	FRN003E1S-7U	FRN003E1E-2U	FRN003E1E-4U	FRN003E1E-7U
5	FRN005E1S-2U	FRN005E1S-4U		FRN005E1E-2U	FRN005E1E-4U	
7.5	FRN007E1S-2U	FRN007E1S-4U		FRN007E1E-2U	FRN007E1E-4U	
10	FRN010E1S-2U	FRN010E1S-4U		FRN010E1E-2U	FRN010E1E-4U	
15	FRN015E1S-2U	FRN015E1S-4U		FRN015E1E-2U	FRN015E1E-4U	
20	FRN020E1S-2U	FRN020E1S-4U		FRN020E1E-2U	FRN020E1E-4U	

How to read the inverter model

FRN 001 E 1 S - 2 U

Code	Series name
FRN	FRENIC series

Code	Applicable motor rating
F12	1/8HP
F25	1/4HP
F50	1/2HP
001	1HP
1	1
010	10HP
015	15HP
020	20HP

Code	Application range
E	High performance/Compact

Code	Developed inverter series
1	Series

Code	Destination, Instruction manuals
U	North America / Canada

Code	Input power source
2	Three-phase 230V
4	Three-phase 460V
7	Single-phase 230V

Code	Enclosure
S	Standard type (IP20)
E	EMC filter built-in type

Caution The contents of this catalog are provided to help you select the product model that is best for you. Before actual use, be sure to read the User's Manual thoroughly to assure correct operation.

Standard type

Three-phase 230V (1/8 to 20HP)

Item		Specifications													
Type (FRN□□□E1S-2U)		F12	F25	F50	001	002	003	005	007	010	015	020			
Applicable motor rating [HP] (*1)		1/8	1/4	1/2	1	2	3	5	7.5	10	15	20			
Output ratings	Rated capacity [kVA] (*2)	0.3	0.6	1.2	2.0	3.2	4.4	6.8	10	13	19	24			
	Rated voltage [V] (*3)	Three-phase 200V to 240V (with AVR function)													
Output ratings	Rated current [A] (*4)	0.8 (0.7)	1.5 (1.4)	3.0 (2.5)	5.0 (4.2)	8.0 (7.0)	11 (10)	17 (16.5)	25 (23.5)	33 (31)	47 (44)	60 (57)			
	Overload capability	150% of rated current for 1min, 200% - 0.5s													
Input power	Rated frequency [Hz]	50, 60Hz													
	Phases, voltage, frequency	Three-phase, 200 to 240V, 50/60Hz													
	Voltage/frequency variations	Voltage: +10 to -15% (Voltage unbalance (*8): 2% or less) Frequency: +5 to -5%													
	Rated current [A] (*9)	(with DCR)	0.57	0.93	1.6	3.0	5.7	8.3	14.0	21.1	28.8	42.2	57.6		
Input power		(without DCR)	1.1	1.8	3.1	5.3	9.5	13.2	22.2	31.5	42.7	60.7	80		
	Required power supply capacity [kVA] (*5)	0.2	0.3	0.6	1.1	2.0	2.9	4.9	7.4	10	15	20			
Braking	Torque [%] (*6)	150			100			70			40			20	
	Torque [%] (*7)	—			150										
	DC injection braking	Starting frequency: 0.1 to 60.0Hz, Braking time: 0.0 to 30.0s, Braking level: 0 to 100% of rated current													
Braking transistor		Built-in													
Applicable safety standards		UL508C, C22.2No.14, EN50178:1997													
Enclosure (IEC60529)		IP20, UL open type													
Cooling method		Natural cooling					Fan cooling								
Weight / Mass [lbs(kg)]		1.3(0.6)	1.3(0.6)	1.5(0.7)	1.8(0.8)	3.7(1.7)	3.7(1.7)	5.1(2.3)	7.5(3.4)	7.9(3.6)	13(6.1)	16(7.1)			

Three-phase 460V (1/2 to 20HP)

Item		Specifications										
Type (FRN□□□E1S-4U)		F50	001	002	003	005	007	010	015	020		
Applicable motor rating [HP] (*1)		1/2	1	2	3	5	7.5	10	15	20		
Output ratings	Rated capacity [kVA] (*2)	1.2	2.0	2.9	4.4	7.2	10	14	19	24		
	Rated voltage [V] (*3)	Three-phase 380V to 480V (with AVR function)										
Output ratings	Rated current [A] (*4)	1.5	2.5	3.7	5.5	9.0	13	18	24	30		
	Overload capability	150% of rated current for 1min, 200% - 0.5s										
Input power	Rated frequency [Hz]	50, 60Hz										
	Phases, voltage, frequency	Three-phase, 380 to 480V, 50/60Hz										
	Voltage/frequency variations	Voltage: +10 to -15% (Voltage unbalance (*8): 2% or less) Frequency: +5 to -5%										
	Rated current [A] (*9)	(with DCR)	0.85	1.6	3.0	4.4	7.3	10.6	14.4	21.1	28.8	
Input power		(without DCR)	1.7	3.1	5.9	8.2	13.0	17.3	23.2	33.0	43.8	
	Required power supply capacity [kVA] (*5)	0.6	1.1	2.0	2.9	4.9	7.4	10	15	20		
Braking	Torque [%] (*6)	100			70			40			20	
	Torque [%] (*7)	150										
	DC injection braking	Starting frequency: 0.1 to 60.0Hz, Braking time: 0.0 to 30.0s, Braking level: 0 to 100% of rated current										
Braking transistor		Built-in										
Applicable safety standards		UL508C, C22.2No.14, EN50178:1997										
Enclosure (IEC60529)		IP20, UL open type										
Cooling method		Natural cooling					Fan cooling					
Weight / Mass [lbs(kg)]		2.4(1.1)	2.6(1.2)	3.7(1.7)	3.7(1.7)	5.1(2.3)	7.5(3.4)	7.9(3.6)	13(6.1)	16(7.1)		

Single-phase 230V (1/8 to 3HP)

Item		Specifications						
Type (FRN□□□E1S-7U)		F12	F25	F50	001	002	003	
Applicable motor rating [HP] (*1)		1/8	1/4	1/2	1	2	3	
Output ratings	Rated capacity [kVA] (*2)	0.3	0.6	1.2	2.0	3.2	4.4	
	Rated voltage [V] (*3)	Three-phase 200V to 240V (with AVR function)						
Output ratings	Rated current [A] (*4)	0.8 (0.7)	1.5 (1.4)	3.0 (2.5)	5.0 (4.2)	8.0 (7.0)	11 (10)	
	Overload capability	150% of rated current for 1min, 200% - 0.5s						
Input power	Rated frequency [Hz]	50, 60Hz						
	Phases, voltage, frequency	Single-phase, 200 to 240V, 50/60Hz						
	Voltage/frequency variations	Voltage: +10 to -10%, Frequency: +5 to -5%						
	Rated current [A] (*9)	(with DCR)	1.1	2.0	3.5	6.4	11.6	17.5
Input power		(without DCR)	1.8	3.3	5.4	9.7	16.4	24.8
	Required power supply capacity [kVA] (*5)	0.3	0.4	0.7	1.3	2.4	3.5	
Braking	Torque [%] (*6)	150			100		70	40
	Torque [%] (*7)	—						150
	DC injection braking	Starting frequency: 0.1 to 60.0Hz, Braking level: 0 to 100% of rated current, Braking time: 0.0 to 30.0s						
Braking transistor		Built-in						
Applicable safety standards		UL508C, C22.2No.14, EN50178:1997						
Enclosure (IEC60529)		IP20, UL open type						
Cooling method		Natural cooling				Fan cooling		
Weight / Mass [lbs(kg)]		1.3(0.6)	1.3(0.6)	1.5(0.7)	2.0(0.9)	4.0(1.8)	5.3(2.4)	

(*1) Fuji's 4-pole standard motor

(*2) Rated capacity is calculated by assuming the output rated voltage as 230V for three-phase 230V series and 460V for three-phase 460V series.

(*3) Output voltage cannot exceed the power supply voltage.

(*4) When setting the carrier frequency (F26) to 3 kHz or less. Use the current () or below when the carrier frequency setting is higher than 4kHz and continuously operating at 100%.

(*5) Obtained when a DC REACTOR is used.

(*6) Average braking torque obtained when reducing the speed from 60Hz with AVR control OFF (Varies with the efficiency of the motor.)

(*7) Average braking torque obtained by use of external braking resistor (standard type available as option)

(*8) Voltage unbalance [%] = $\frac{\text{Max voltage [V]} - \text{Min voltage [V]}}{\text{Three-phase average voltage [V]}} \times 67$ (IEC 61800-3)

If this value is 2 to 3%, use AC REACTOR (ACR: option).

(*9) The value is calculated on assumption that the inverter is connected with a power supply capacity of 500kVA (or 10 times the inverter capacity if the inverter capacity exceeds 50kVA) and %X is 5%.

● Semi-standard type

EMC filter built-in type

■ Three-phase 230V (1/8 to 20HP)

Item		Specifications										
Type (FRN□□□E1E-2U)		F12	F25	F50	001	002	003	005	007	010	015	020
Nominal applied motor [HP] (*1)		1/8	1/4	1/2	1	2	3	5	7.5	10	15	20
Output ratings	Rated capacity [kVA] (*2)	0.30	0.57	1.1	1.9	3.0	4.1	6.4	9.5	12	17	22
	Rated voltage [V] (*3)	Three-phase 200 to 240V (with AVR)										
	Rated current [A] (*4)	0.8 (0.7)	1.5 (1.4)	3.0 (2.5)	5.0 (4.2)	8.0 (7.0)	11 (10)	17 (16.5)	25 (23.5)	33 (31)	47 (44)	60 (57)
Overload capability		150% of rated current for 1min or 200% of rated current for 0.5s										
Rated frequency [Hz]		50, 60Hz										
Input ratings	Phases, voltage, frequency		Three-phase, 200 to 240V, 50/60Hz									
	Voltage/frequency variations		Voltage: +10 to -15% (Voltage unbalance : 2% or less (*7)) Frequency: +5 to -5%									
	Rated current [A] (*8)	(with DCR) (without DCR)	0.57 1.1	0.93 1.8	1.6 3.1	3.0 5.3	5.7 9.5	8.3 13.2	14.0 22.2	21.1 31.5	28.8 42.7	42.2 60.7
Required power supply capacity [kVA] (*5)		0.2	0.3	0.6	1.1	2.0	2.9	4.9	7.4	10	15	20
Braking	Torque [%] (*6)		150		100		70		40		20	
	DC injection braking		Starting frequency: 0.0 to 60.0Hz, Braking time: 0.0 to 30.0s, Braking level: 0 to 100%									
	Braking transistor		Built-in									
Applicable safety standards		UL508C, C22.2No.14(pending), EN50178:1997										
Enclosure		IP20(IEC60529)/UL open type(UL50)										
Cooling method		Natural cooling					Fan cooling					
EMC standard compliance	Emission	Class 1A (EN55011:1998/A1:1999)						2nd Env. (EN61800-3:1996+A11:2000)				
	Immunity	2nd Env. (EN61800-3:1996/A11:2000)										
Weight / Mass [lbs(kg)]		1.5(0.7)	1.5(0.7)	1.8(0.8)	2.0(0.9)	5.3(2.4)	5.3(2.4)	6.4(2.9)	11.2(5.1)	11.7(5.3)	22.7(10.3)	24.9(11.3)

■ Three-phase 460V (1/2 to 20HP)

Item		Specifications										
Type (FRN□□□E1E-4U)		F50	001	002	003	005	007	010	015	020		
Nominal applied motor [HP] (*1)		1/2	1	2	3	5	7.5	10	15	20		
Output ratings	Rated capacity [kVA] (*2)	1.1	1.9	2.8	4.1	6.8	9.9	13	18	24	30	
	Rated voltage [V] (*3)	Three-phase 380 to 480V (with AVR)										
	Rated current [A] (*4)	1.5	2.5	3.7	5.5	9.0	13	18	24	30		
Overload capability		150% of rated current for 1min or 200% of rated current for 0.5s										
Rated frequency [Hz]		50, 60Hz										
Input ratings	Phases, voltage, frequency		Three-phase, 380 to 480V, 50/60Hz									
	Voltage/frequency variations		Voltage: +10 to -15% (Voltage unbalance: 2% or less (*7)), Frequency: +5 to -5%									
	Rated current [A] (*8)	(with DCR) (without DCR)	0.85 1.7	1.6 3.1	3.0 5.9	4.4 8.2	7.3 13.0	10.6 17.3	14.4 23.2	21.1 33.0	28.8 43.8	
Required power supply capacity [kVA] (*5)		0.6	1.1	2.0	2.9	4.9	7.4	10	15	20		
Braking	Torque [%] (*6)		100		70		40		20			
	DC injection braking		Starting frequency: 0.0 to 60.0Hz, Braking time: 0.0 to 30.0s, Braking level: 0 to 100%									
	Braking transistor		Built-in									
Applicable safety standards		UL508C, C22.2No.14 (pending), EN50178:1997										
Enclosure		IP20 (IEC60529)/UL open type (UL50)										
Cooling method		Natural cooling					Fan cooling					
EMC standard compliance	Emission	Class 1A (EN55011:1998/A1:1999)						2nd Env. (EN61800-3:1996+A11:2000)				
	Immunity	2nd Env. (EN61800-3:1996/A11:2000)										
Weight / Mass [lbs(kg)]		3.3(1.5)	3.5(1.6)	5.5(2.5)	5.5(2.5)	6.6(3.0)	10.6(4.8)	11.0(5.0)	17.9(8.1)	20.0(9.1)		

■ Single-phase 230V (1/8 to 3HP)

Item		Specifications						
Type (FRN□□□E1E-7U)		F12	F25	F50	001	002	003	
Nominal applied motor [HP] (*1)		1/8	1/4	1/2	1	2	3	
Output ratings	Rated capacity [kVA] (*2)	0.3	0.57	1.1	1.9	3.0	4.1	
	Rated voltage [V] (*3)	Three-phase 200 to 240V (with AVR)						
	Rated current [A] (*4)	0.8 (0.7)	1.5 (1.4)	3.0 (2.5)	5.0 (4.2)	8.0 (7.0)	11 (10)	
Overload capability		150% of rated current for 1min or 200% of rated current for 0.5s						
Rated frequency [Hz]		50, 60Hz						
Input ratings	Phases, voltage, frequency		Single-phase, 200 to 240V, 50/60Hz					
	Voltage/frequency variations		Voltage: +10 to -10%, Frequency: +5 to -5%					
	Rated current [A] (*8)	(with DCR) (without DCR)	1.1 1.8	2.0 3.3	3.5 5.4	6.4 9.7	11.6 16.4	17.5 24.8
Required power supply capacity [kVA] (*5)		0.3	0.4	0.7	1.3	2.4	3.5	
Braking	Torque [%] (*6)		150		100		70	40
	DC injection braking		Starting frequency: 0.0 to 60.0Hz, Braking time: 0.0 to 30.0s, Braking level: 0 to 100%					
	Braking transistor		Built-in					
Applicable safety standards		UL508C, C22.2No.14 (pending), EN50178:1997						
Enclosure		IP20 (IEC60529)/UL open type (UL50)						
Cooling method		Natural cooling				Fan cooling		
EMC standard compliance	Emission	Class 1A (EN55011:1998/A1:1999)						
	Immunity	2nd Env. (EN61800-3:1996/A11:2000)						
Weight / Mass [lbs(kg)]		1.5(0.7)	1.5(0.7)	1.8(0.8)	2.9(1.3)	5.5(2.5)	6.6(3.0)	

*1) Fuji's 4-pole standard motor

*2) Rated capacity is calculated by regarding the output rated voltage as 230V for three-phase 230V series and 460V for three-phase 460V series.

*3) Output voltage cannot exceed the power supply voltage.

*4) The load shall be reduced so that the continuous operating current is the rated current in parenthesis or less if the carrier frequency is set to 4kHz or above.

*5) Obtained when a DC REACTOR is used.









*6) Average braking torque when a motor of no load decelerates. (Varies with the efficiency of the motor.)

*7) Voltage unbalance [%] = $\frac{\text{Max. voltage [V]} - \text{Min. voltage [V]}}{\text{Three-phase average voltage [V]}} \times 67$ (IEC61800-3(5.2.3))

If this value is 2 to 3%, use an AC REACTOR.

*8) The currents are calculated on the condition that the inverters are connected to power supply of 500kVA, %X=5%.

Common specifications

Item		Explanation	Remarks	Related function code	
Output frequency	Setting range				
	Maximum frequency	25 to 400Hz variable setting		F03	
	Base frequency	25 to 400Hz variable setting		F04	
	Starting frequency	0.1 to 60.0Hz variable setting, Duration: 0.0 to 10.0s		F23,F24	
	Carrier frequency	0.75 to 15kHz variable setting	Frequency may drop automatically to protect the inverter depending on environmental temperature and output current. This protective operation can be canceled by function code H98.	F26 F27 H98	
Accuracy (Stability)	<ul style="list-style-type: none"> Analog setting: $\pm 0.2\%$ of maximum frequency (at $25 \pm 10^\circ\text{C}$ (at $77 \pm 50^\circ\text{F}$)) Keypad setting: $\pm 0.01\%$ of maximum frequency (at -10 to $+50^\circ\text{C}$ (at 14 to $+122^\circ\text{F}$)) 				
Setting resolution	<ul style="list-style-type: none"> Analog setting: 1/3000 of maximum frequency (ex. 0.02Hz at 60Hz, 0.4Hz at 120Hz) Keypad setting: 0.01Hz (99.99Hz or less), 0.1Hz (100.0Hz or more) Link setting: Selectable from 2 types <ul style="list-style-type: none"> 1/2000 of maximum frequency (ex. 0.003Hz at 60Hz, 0.006Hz at 120Hz) 0.01Hz (fixed) 	Setting with  and  keys			
Control	Control method	V/f control • Dynamic torque-vector control (magnetic flux estimator) • V/f control (with sensor, when the PG interface card (option) is installed)			
	Voltage/freq. characteristic (Non-linear V/f setting)	Possible to set output voltage at base frequency and at maximum output frequency (common spec). AVR control can be turned ON or OFF (Factory setting: OFF).	Three-phase 230V, single-phase 230V: 80 to 240V Three-phase 460V: 160 to 500V	F03 to F06	
		2 points (Desired voltage and frequency can be set.)	Three-phase and single-phase 230V: 0 to 240V/0 to 400Hz Three-phase 400V: 0 to 500V/0 to 400Hz	H50 to H53	
	Torque boost (Load selection)	Torque boost can be set with the function code F09.	Set when 0, 1, 3, or 4 is selected at F37.	F09, F37 F09, F37	
		Select application load type with the function code F37.			
		0: Squared variable torque load			
		1: Constant torque load			
		2: Auto torque boost			
	3: Auto energy-save operation (variable torque load in deceleration)				
	4: Auto energy-save operation (constant torque load)				
	5: Auto energy-save operation (auto torque boost)				
	Starting torque	200% or over (Auto torque boost in 0.5Hz operation, slip compensation and auto torque boost)		H68, F37	
	Start/stop	Keypad operation	Start and stop with  and  keys	Keypad (standard)	F02
			Start and stop with  /  and  keys	Multi-function keypad	F02
		External signals (7 digital inputs): FWD (REV), RUN, STOP commands (3 wire operation possible), coast-to-stop, external alarm, alarm reset, etc.		E01 to E05 E98, E99	
Linked operation: Operation through RS-485 or field buss (option) communications			H30, y98		
Switching operation command: Link switching, switching between communication and inverter (keypad or external signals)					
Frequency setting	Key operation: Can be set with  and  keys	With data protection	F01, C30		
	External volume: Can be set with external potentiometer (1 to 5k Ω /2W)	Connected to analog input terminals 13, 12, and 11. Potentiometer must be provided.			
	Analog input	Analog input can be set with external voltage/current input <ul style="list-style-type: none"> 0 to $\pm 10\text{V DC}$ (0 to $\pm 5\text{V DC}$)/0 to $\pm 100\%$ (terminal 12, C1 (V2)) +4 to +20mA DC/0 to 100% (terminal C1) 	<ul style="list-style-type: none"> 0 to +5V DC can be used depending on the analog input gain (200%). +1 to +5V DC can be adjusted with bias and analog input gain. Voltage can be input (terminal V2) to the terminal 1. 	F18, C50, C32 to C34, C37 to C39, C42 to C44	
	Multistep frequency: Selectable from 16 steps (step 0 to 15)		C05 to C19		
	UP/DOWN operation: Frequency can be increased or decreased while the digital input signal is ON.		F01, C30		
	Linked operation: Frequency can be set through RS-485 or field buss (optional) communications.		H30, y98		
	Switching frequency setting: Frequency setting can be switched (2 settings) with external signal (digital input). Switching to frequency setting via communication and multi-frequency setting are available.		F01, C30		
	Auxiliary frequency setting: Terminal 12 input and terminal C1 input (terminal V2 input) can be added to main setting as auxiliary frequency.		E61 to E63		
	Inverse operation: Normal/inverse operation can be set or switched with digital input signal and function code setting. <ul style="list-style-type: none"> +10 to 0V DC /0 to 100% (terminal 12, C1 (V2)) +20 to +4mA DC/0 to 100% (terminal C1) 		C53		
	Pulse train input: 30kHz (max./) Maximum output frequency	When the PG interface card (optional) is installed.			
Acceleration/deceleration time (Curve)	0.00 to 3600s *If 0.00s is set, the time setting is cancelled and acceleration and deceleration is made according to the pattern given with an external signal.		F07, F08		
	Acceleration and deceleration time can be independently set with 2 types and selected with digital input signal (1 point).		E10, E11		
	Acceleration and deceleration pattern can be selected from 4 types: Linear, S-curve (weak), S-curve (strong), Non-linear		H07		
Deceleration with coasting can be stopped with operation stop command.		H11			
Frequency limiter (Upper limit and lower limit frequencies)	High and Low limiters can be set. (Setting range: 0 to 400Hz)	If the set frequency is lower than lower limit, continuous motor running or stop running motor can be selected.	F15, F16 H63		
Bias	Bias of set frequency and PID command can be independently set (setting range: 0 to $\pm 100\%$).		F18, C50 to C52		
Gain	Analog input gain can be set between 0 and 200%.	Voltage signal from terminal 12, C1 (V2) and current signal (from terminal C1) can be set independently.	C32, C34, C37 C39, C42, C44		
Jump frequency	Three operation points and their common jump width (0 to 30.0Hz) can be set.		C01 to C04		
Timer operation	The inverter operates and stops for the time set with the keypad (1-cycle operation).		C21		
Jogging operation	<ul style="list-style-type: none"> Can be operated using digital input signal or keypad. Acceleration and deceleration time (same duration used only for jogging) can be set. Jogging frequency: 0.00 to 400.0Hz 		H54 C20		
Auto-restart after momentary power failure	<ul style="list-style-type: none"> Restarts the inverter without stopping the motor after instantaneous power failure. Select "Continuous motor mode" to wait for the power recovering with low output frequency. Restart at 0Hz, restart from the frequency used before momentary power failure, restart at the set frequency can be selected. Motor speed at restart can be searched and restarted. 		F14 H13 to H16 H92, H93		
Torque limit	<ul style="list-style-type: none"> Controls the output torque lower than the set limit value. Can be switched to the second torque limit with digital input signal. Soft start (filter function) is available when switching the torque control to 1/2. 		F40, F41 E16, E17 H76		
Current limit	Keeps the current under the preset value during operation.		F43, F44		
Slip compensation	<ul style="list-style-type: none"> Compensates for decrease in speed according to the load, enabling stable operation. Time constant can be changed. Possible to enable or disable slip compensation during acceleration/deceleration or in constant output range. 		H68 P09 to P12		
Droop control	Decrease the speed according to the load torque.		H28		

Item	Explanation	Remarks	Related function code									
Control	PID control	Control with PID regulator or dancer controller. <ul style="list-style-type: none"> ■ Process command <ul style="list-style-type: none"> • Key operation (and keys) : 0 to 100% • Analog input (terminal 12, C1 (V2)) : 0 to ±10V DC/0 to ±100% • Analog input (terminal C1) : 4 to 20mA DC/0 to 100% • UP/DOWN (digital input) : 0 to 100% • Communication (RS-485, bus option) : 0 to 20000/0 to 100% ■ Feedback value <ul style="list-style-type: none"> • Analog input from terminal 12, C1 (V2) : 0 to ±10V DC/0 to ±100% • Analog input (terminal C1) : 4 to 20mA DC/0 to 100% ■ Accessory functions <ul style="list-style-type: none"> • Alarm output (absolute value alarm, deviation alarm) • Normal operation/inverse operation • PID output limiter • Anti-reset wind-up function • Integration reset/hold 		E61 to E63 J01 to J06 J10 to J19								
	Pick-up	Operation begins at a preset pick-up frequency to search for the motor speed to start an idling motor without stopping it.		H09, H13, H17								
	Automatic deceleration	When the torque calculation value exceeds the limit level set for the inverter during deceleration, the output frequency is automatically controlled and the deceleration time automatically extends to avoid an OU trip.	Trip may occur due to load conditions.	H69, F08								
	Deceleration characteristic	The motor loss increases during deceleration to reduce the load energy regenerating at the inverter to avoid an OU trip upon mode selection.		H71								
	Automatic energy-saving operation	The output voltage is controlled to minimize the total sum of the motor loss and inverter loss at a constant speed.		F37, F09								
	Overload Prevention Control	The output frequency is automatically reduced to suppress the overload protection trip o inverter caused by an increase in the ambient temperature, operation frequency, motor load or the like.		H70								
	Auto-tuning	The motor parameters are automatically tuned.	Mode that the motor rotates and mode that the motor does not rotate can be selected.	P04								
	Cooling fan ON/OFF control	Detects inverter internal temperature and stops cooling fan when the temperature is low.	An external output is issued in a transistor output signal.	H06								
	Secondary motor setting	<ul style="list-style-type: none"> • One inverter can be used to control two motors by switching (switching is not available while a motor is running). Base frequency, rated current, torque boost, electronic thermal, slip compensation can be set as data for the secondary motor. • The second motor constants can be set in the inverter. (Auto-tuning possible) 										
	Universal DI	The presence of digital signal in a device externally connected to the set terminal can be sent to the master controller.										
	Universal AO	The output from the master controller can be output from the terminal FM.										
	Speed control	The motor speed can be detected with the pulse encoder and speed can be controlled.	When the PG interface card (optional) is installed.									
	Positioning control	Only one program can be executed by setting the number of pulses to the stop position and deceleration point.	When the PG interface card (optional) is installed.									
Rotation direction control	Select either of reverse prevention or forward rotation prevention.											
Indication	Running/stopping	<ul style="list-style-type: none"> • Speed monitor, output current [A], output voltage [V], torque calculation value, input power [HP], PID reference value, PID feedback value, PID output, load factor, motor output, period for timer operation [s] ◆ Select the speed monitor to be displayed from the following: Output frequency [Hz], Output frequency 1 [Hz] (before slip compensation), Output frequency 2 (after slip compensation) [Hz], Motor speed (set value) [r/min], Motor speed [r/min], Load shaft speed (set value) [r/min], Load shaft speed [r/min], Line speed (set value), Line speed [r/min] 		E43 E48								
	Life early warning	The life early warning of the main circuit capacitors, capacitors on the PC boards and the cooling fan can be displayed.	An external output is issued in a transistor output signal.									
	Cumulative run hours	The cumulative motor running hours, cumulative inverter running hours and cumulative watt-hours can be displayed.										
	I/O check	Displays the input signal status of the inverter.										
	Power monitor	Displays input power (momentary), accumulated power, electricity cost (accumulated power x displayed coefficient).										
	Trip mode	Displays the cause of trip by codes. <ul style="list-style-type: none"> • OC 1 (Overcurrent during acceleration) • OC 2 (Overcurrent during deceleration) • OC 3 (Overcurrent at constant speed) • LU 1 (Input phase loss) • LU 2 (Undervoltage) • OP 1 (Output phase loss) • OU 1 (Overvoltage during acceleration) • OU 2 (Overvoltage during deceleration) • OU 3 (Overvoltage at constant speed) • OH 1 (Overheating of the heat sink) • OH 2 (External alarm) • OH 3 (Inverter overheat) • OH 4 (Motor protection (PTC thermistor)) • OL 1 (Motor 1 overload) • OL 2 (Motor 2 overload) • OL 3 (Inverter overload) • dbH (Overheating of braking resistor) • PG (PG disconnection) • Er 1 (Memory error) • Er 2 (Keypad communication error) • Er 3 (CPU error) • Er 4 (Optional communication error) • Er 5 (Option error) • Er 6 (Operation error) • Er 7 (Tuning error) • Er 8 (RS-485 communication error) • Er F (Data save error due to undervoltage) • Er P (RS485 communication error (option)) • Er H (Power LSI error) • Er r (Simulation error) 										
	Running or trip mode	Trip history: Saves and displays the last 4 trip codes and their detailed description.		E52								
	Overcurrent protection	The inverter is stopped upon an overcurrent caused by an overload.										
	Short circuit protection	The inverter is stopped upon an overcurrent caused by a short circuit in the output circuit.										
	Grounding fault protection	The inverter is stopped upon an overcurrent caused by a grounding fault in the output circuit.										
Overvoltage protection	An excessive DC link circuit voltage is detected to stop the inverter.	3-phase 230V / 400V DC, Single-phase 230V/400V DC 3-phase 460V / 800V DC										
Undervoltage	Stops the inverter by detecting voltage drop in DC link circuit.	3-phase 230V / 200V DC, Single-phase 230V/200V DC 3-phase 460V / 400V DC	F14									
Input phase loss	Stops or protects the inverter against input phase loss.	The protective function can be canceled with function code 99.	H98									
Output phase loss	Detects breaks in inverter output wiring at the start of running and during running, stopping the inverter output.	The protective function can be canceled with function code 99.	H98									
Overheating	The temperature of the heat sink of the inverter or that inside the inverter unit is detected to stop the inverter, upon a failure or overload of the cooling fan.		H43									
Overload	The inverter is stopped upon the temperature of the heat sink of the inverter or the temperature of the switching element calculated from the output current.											
Protection	Motor protection	Electronic thermal	The inverter is stopped upon an electronic thermal function setting to protect the motor.	Thermal time constant can be adjusted (0.5 to 75.0min.)	F10 to F12, P99							
		PTC thermistor	A PTC thermistor input stops the inverter to protect the motor.		H26, H27							
		Overload early warning	Warning signal can be output based on the set level before the inverter trips.		F10, F12, E34, E35, P99							
	Stall prevention	The output frequency decreases upon an output current exceeding the limit during acceleration or constant speed operation, to avoid overcurrent trip.		H12								
	Momentary power failure protection	<ul style="list-style-type: none"> • A protective function (inverter stoppage) is activated upon a momentary power failure for 15msec or longer. • If restart upon momentary power failure is selected, the inverter restarts upon recovery of the voltage within the set time. 		H13 to H16 F14								
	Retry function	When the motor is tripped and stopped, this function automatically resets the tripping state and restarts operation.	Waiting time before resetting and the number of retry times can be set.	H04, H05								
	Command loss detection	A loss (broken wire, etc.) of the frequency command is detected to output an alarm and continue operation at the preset frequency (set at a ratio to the frequency before detection).		E65								
	Environment	Installation location	Shall be free from corrosive gases, flammable gases, oil mist, dusts, and direct sunlight. (Pollution degree 2 (IEC60664-1)). Indoor use only.									
		Ambient temperature	-10 to +50°C(at +14 to +122°F)	-10 to 40°C(+14 to +104°F)when inverters are installed side by side without clearance.								
		Ambient humidity	5 to 95% RH (without condensation)									
Altitude		<table border="1"> <thead> <tr> <th>Altitude [ft(m)]</th> <th>Output decrease</th> </tr> </thead> <tbody> <tr> <td>Lower than 3,300(1,000)</td> <td>None</td> </tr> <tr> <td>3,301 to 6,600(1,001 to 2,000)</td> <td>Decreases</td> </tr> <tr> <td>6,601 to 9,800(2,001 to 3,000)</td> <td>Decreases*</td> </tr> </tbody> </table>	Altitude [ft(m)]	Output decrease	Lower than 3,300(1,000)	None	3,301 to 6,600(1,001 to 2,000)	Decreases	6,601 to 9,800(2,001 to 3,000)	Decreases*	* If the altitude exceeds 6,600ft(2,000m) insulate the interface circuit from the main power supply to conform to the Low Voltage Directives.	
Altitude [ft(m)]		Output decrease										
Lower than 3,300(1,000)	None											
3,301 to 6,600(1,001 to 2,000)	Decreases											
6,601 to 9,800(2,001 to 3,000)	Decreases*											
Vibration	3mm (vibration width): 2 to less than 9Hz, 9.8m/s ² : 9 to less than 20Hz, 2m/s ² : 20 to less than 55Hz, 1m/s ² : 55 to less than 200Hz											
Storage	Ambient temp.	-25 to +65°C(-13 to +149°F)										
	Ambient humidity	5 to 95%RH (without condensation)										

● Inverter outline (standard type)

Fig. a

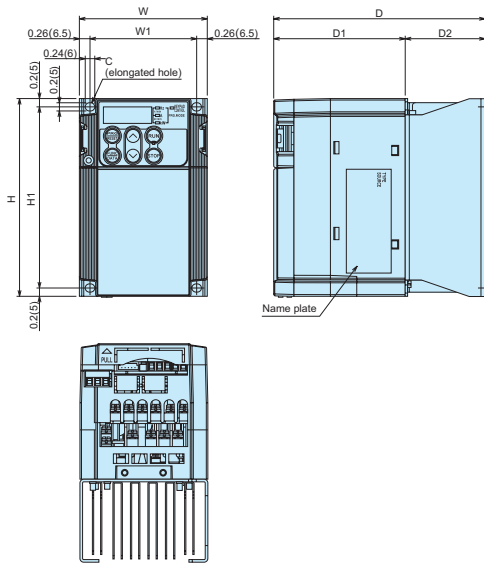

Fig. b

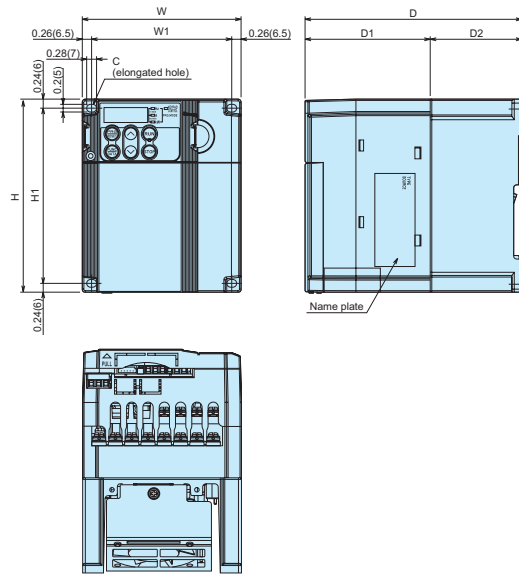

Fig. c

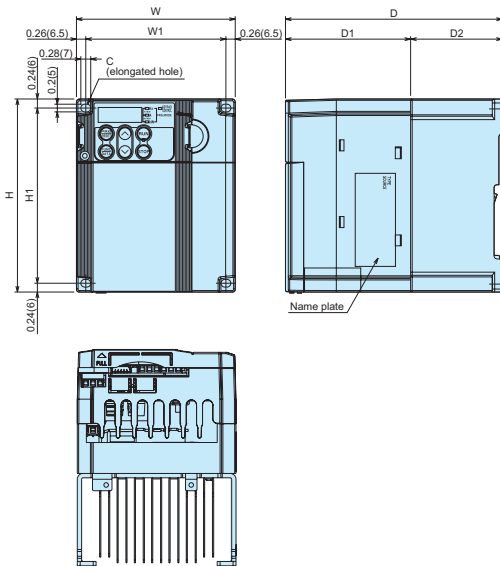

Fig. d

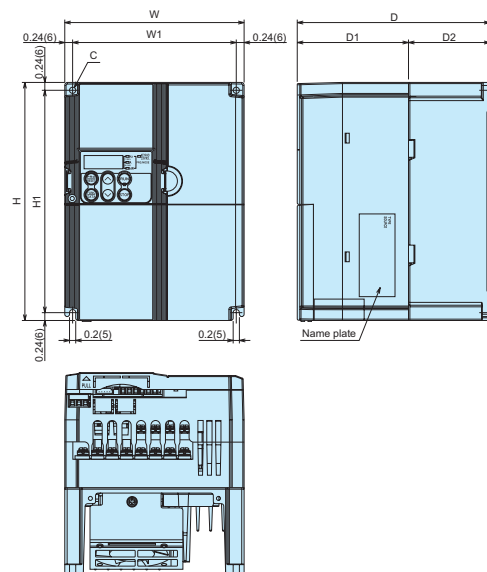

Fig. e

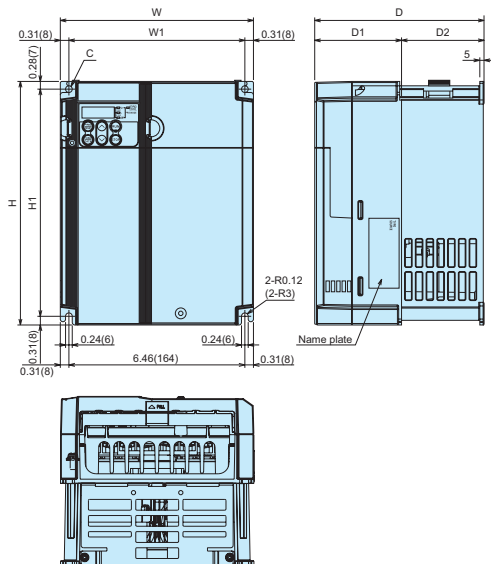
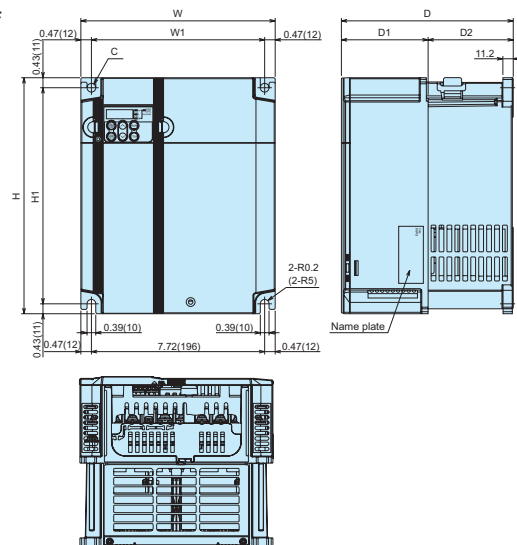

Fig. f



● Inverter outline (EMC filter built-in type)

Fig. g

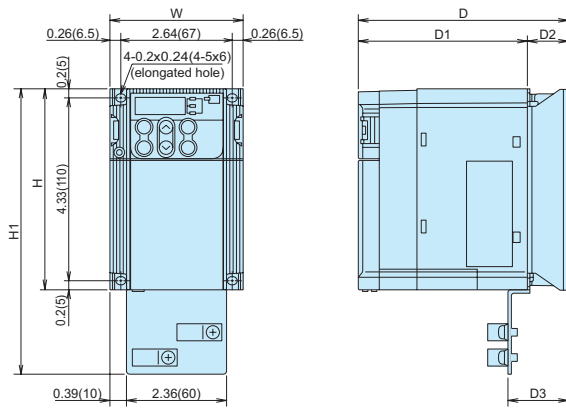

Fig. h

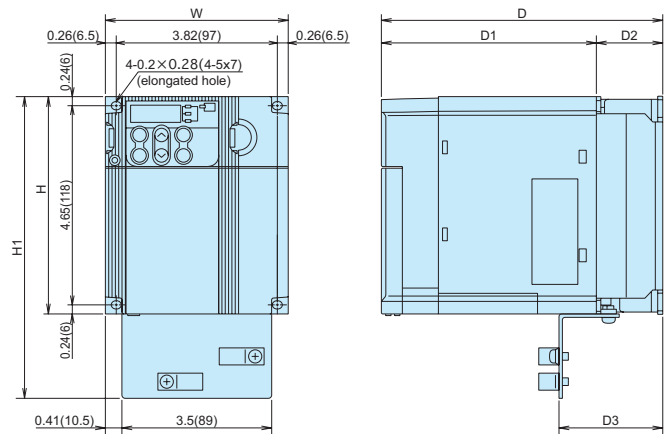

Fig. i

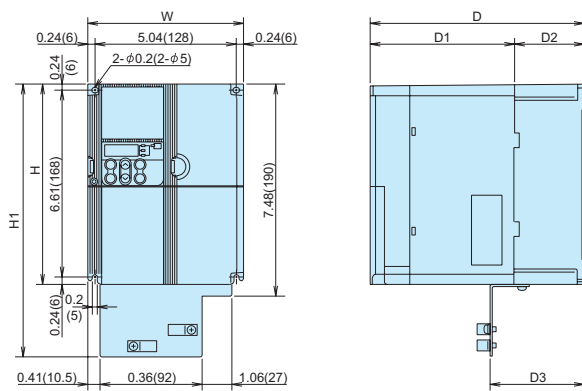

Fig. j

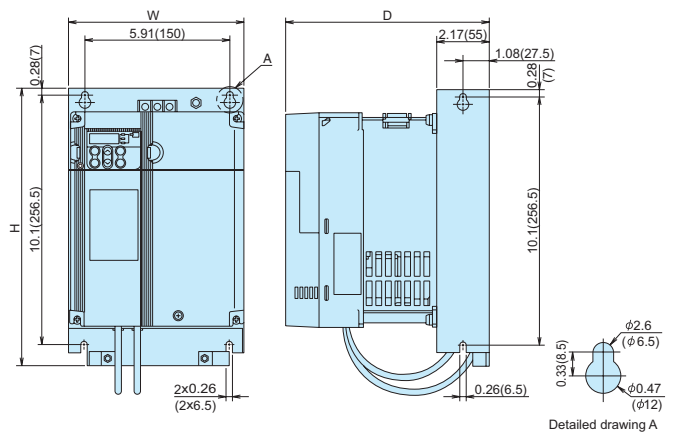

Fig. k

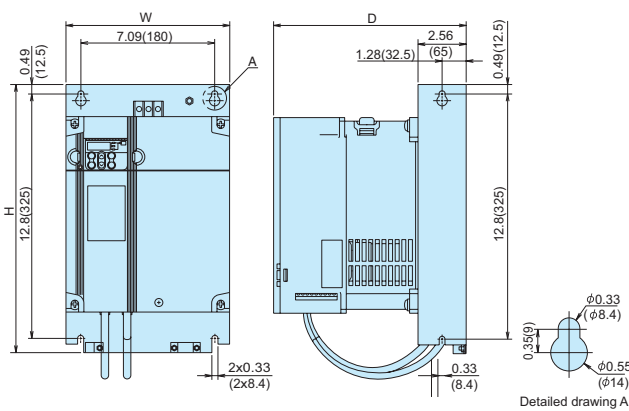
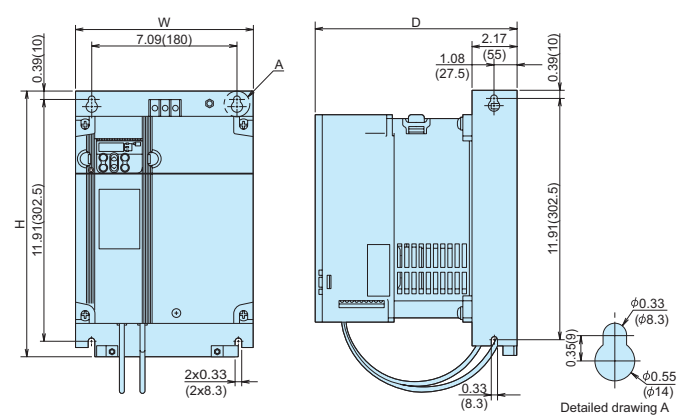

Fig. l



Power supply voltage	Inverter type	Fig.	Dimensions [Unit: inch (mm)]													
			W	H	H1	D	D1	D2	D3							
Three-phase 230V	FRNF12E1S-2U	g	3.15 (80)	4.72 (120)	6.69 (170)	4.41	4.02 (102)	0.39	0.83							
	(112)					(10)		(21.2)								
	5.00(127)					0.98(25)		1.43(36.2)								
	5.98(152)					1.97(50)		2.41(61.2)								
	FRNF25E1S-2U	i	5.51 (140)	7.09 (180)	9.65 (245)	7.64	5.12 (130)	2.52	3.37							
	(194)					(64)		(85.5)								
	FRNF50E1S-2U					j		7.15 (181.5)	11.22 (285)	—	—	—	—			
	FRN001E1S-2U	k	8.66 (220)	13.78 (357)	—		—			—						
	FRN002E1S-2U				h	4.33 (110)		5.12 (130)	7.09 (180)		6.65(169)	5.08 (129)	1.57(40)	2.42(61.5)		
	FRN003E1S-2U	i	5.51 (140)	7.09 (180)			9.65 (245)			7.64	5.12 (130)		2.52	3.37		
FRN005E1S-2U	j									7.15 (181.5)			11.22 (285)	—	—	—
FRN007E1S-2U		l	8.66 (220)	13.07 (332)			—				9.98			—		
FRN010E1S-2U	i				5.51 (140)	7.09 (180)		9.65 (245)	7.64	5.12 (130)	2.52	3.37				
FRN015E1S-2U									j		7.15 (181.5)	11.22 (285)	—		—	—
FRN020E1S-2U	k				8.66 (220)	13.78 (357)		—		—			—			
Three-phase 460V		FRNF50E1S-4U	h	4.33 (110)			5.12 (130)	7.09 (180)	6.65(169)		5.08 (129)	1.57(40)		2.42(61.5)		
	FRN001E1S-4U	i			5.51 (140)	7.09 (180)			9.65 (245)	7.64		5.12 (130)	2.52	3.37		
	FRN002E1S-4U		j	7.15 (181.5)			11.22 (285)	—		—	—		—			
	FRN003E1S-4U	l			8.66 (220)	13.07 (332)		—	9.98			—		—	—	
	FRN005E1S-4U		i	5.51 (140)			7.09 (180)		9.65 (245)	7.64	5.12 (130)		2.52			3.37
	FRN007E1S-4U									j			7.15 (181.5)			11.22 (285)
FRN010E1S-4U	k		8.66 (220)	13.07 (332)			—		—		—					
FRN015E1S-4U		h			4.33(110)	5.12(130)	7.09(180)	5.91(150)		4.33(110)		1.57(40)	2.17(55.2)			
FRN020E1S-4U	i		5.51 (140)	7.09 (180)				9.65 (245)	7.64		5.12 (130)	2.52	3.37			
Single-phase 230V		FRNF12E1S-7U			g	3.15 (80)	4.72 (120)		6.69 (170)	4.41		4.02 (102)	0.39	0.83		
	FRNF25E1S-7U	(112)	(10)	(21.2)												
	FRNF50E1S-7U	5.00(127)	0.98(25)	1.43(36.2)												
	FRN001E1S-7U	5.98(152)	1.97(50)	2.41(61.2)												
	FRN002E1S-7U	h	4.33(110)	5.12(130)	7.09(180)	5.91(150)	4.33(110)	1.57(40)	2.17(55.2)							
	FRN003E1S-7U					i		5.51 (140)	7.09 (180)	9.65 (245)	7.64	5.12 (130)	2.52	3.37		

Keypad switches and functions

LED monitor

When the motor is running or stopped:

The monitor displays speeds, such as output frequency, set frequency, motor speed and load shaft speed, output voltage, output current, and power consumption.

Alarm mode:

The monitor shows the alarm description with a fault code.

Program/Reset key

Used to change the mode.

Programming mode:

Used to shift the digit (cursor movement) to set data.

Alarm mode:

Resets trip prevention mode.

Function/Data select key

Used to change the LED monitor and to store the function code and data.

Up/Down keys

During operation: Used to increase or decrease the frequency or motor speed.

In data setting: Used to indicate the function code number or to change data set value.

Unit display

The unit of the data displayed at the LED monitor is indicated. Use the **FUNC DATA** key to switch the displayed data.

Operation mode display

During keypad operation:

When function code **F 02** is, **0 2** or **3** (keypad operation), the green KEYPAD CONTROL LED lights up.

Run key

While the motor is stopped:

Used to start the operation.

This key is invalid if the function code **F 02** (operation by external signals) is set to **1**.

During operation:

The green RUN LED lights up.

Stop key

Used to stop the operation.

During operation:

This key is invalid if the function code **F 02** (operation by external signals) is set to **1**.

The inverter stops when the function code **H 96** is set to **1** or **3**.



Monitor display and key operation

The keypad modes are classified into the following 3 modes.

Operation mode		Programming mode		Running mode		Alarm mode		
		STOP	RUN	STOP	RUN			
Monitor		Function	Displays the function code and data.		Displays the output frequency, set frequency, loaded motor speed, power consumption, output current, and output voltage.		Displays the alarm description and alarm history.	
		Display	Lighting		Blinking	Lighting	Blinking/Lighting	
	<input type="checkbox"/> Hz <input type="checkbox"/> r/min <input type="checkbox"/> A <input type="checkbox"/> m/min <input type="checkbox"/> kW	Function	Indicates that the program mode is selected.		Displays the units of frequency, output current, power consumption, and rotation speed.		None	
		Display	<input checked="" type="checkbox"/> Hz <input type="checkbox"/> r/min <input type="checkbox"/> A <input type="checkbox"/> m/min <input checked="" type="checkbox"/> kW PRG.MODE ON		Frequency display <input checked="" type="checkbox"/> Hz <input type="checkbox"/> r/min <input type="checkbox"/> A <input type="checkbox"/> m/min <input checked="" type="checkbox"/> kW PRG.MODE ON	Speed display <input checked="" type="checkbox"/> Hz <input type="checkbox"/> r/min <input checked="" type="checkbox"/> A <input type="checkbox"/> m/min <input type="checkbox"/> kW PRG.MODE ON	Capacity or Current indication <input type="checkbox"/> Hz <input type="checkbox"/> r/min <input type="checkbox"/> A <input type="checkbox"/> m/min <input checked="" type="checkbox"/> kW PRG.MODE blinks or lit	OFF
	<input type="checkbox"/> KEYPAD CONTROL	Function	Operation selection (keypad operation/terminal operation) is displayed.					
		Display	Lit in keypad operation mode					
<input type="checkbox"/> RUN	Function	Indicates absence of operation commands.	Indicates presence of operation commands.	Indicates absence of operation commands.	Indicates presence of operation commands.	Indicates that the operation is trip-stopped.		
	Display	<input type="checkbox"/> RUN unlit	<input checked="" type="checkbox"/> RUN lit	<input type="checkbox"/> RUN unlit	<input checked="" type="checkbox"/> RUN lit	If an alarm occurs during operation, the lamp is unlit during keypad operation and lit during terminal block operation.		
Keys		Function	Switches to running mode		Switches to programming mode		Releases the trip and switches to stop mode or running mode.	
		Function	Digit shift (cursor movement) in data setting					
		Function	Determines the function code, stores and updates data.		Switches the LED monitor display.		Displays the operation information.	
		Function	Increases/decreases the function code and data.		Increases/decreases the frequency, motor speed and other settings.		Displays the alarm history.	
		Function	Invalid		Starts running (switches to running mode (RUN)).	Invalid	Invalid	
	Function	Invalid	Deceleration stop (switches to programming mode (STOP)).	Invalid	Deceleration stop (switches to running mode (STOP)).	Invalid		

This keypad supports the full menu mode that allows you to set or display the following information. Indication and setting change of changed function code, drive monitor, I/O check, maintenance information, and alarm information. For the actual operation methods, refer to the FRENIC-Multi Instruction Manual or User's Manual.

●Wiring diagram

The following diagram is for reference only. For detailed wiring diagrams, refer to the instruction manual.

■Keypad operation

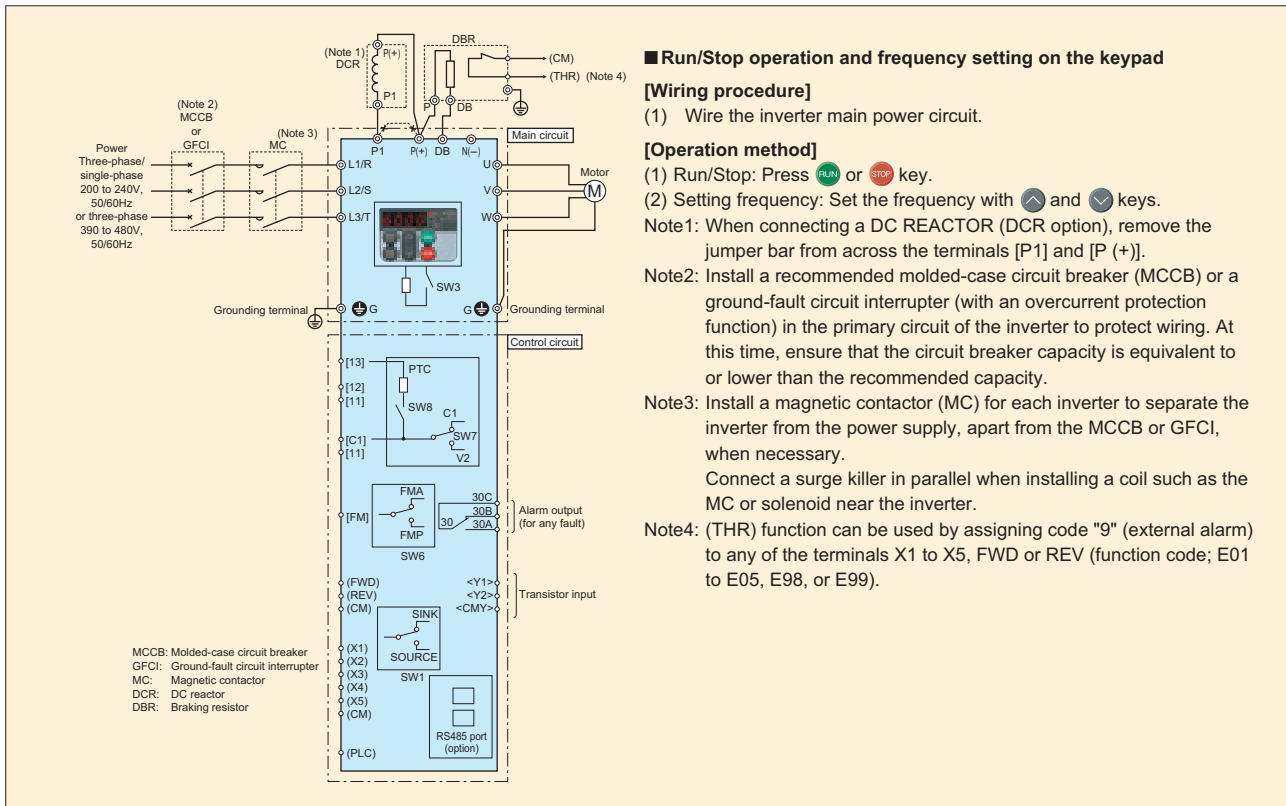

Keypad Operations
Basic Wiring Diagram

■Operation by external signal inputs

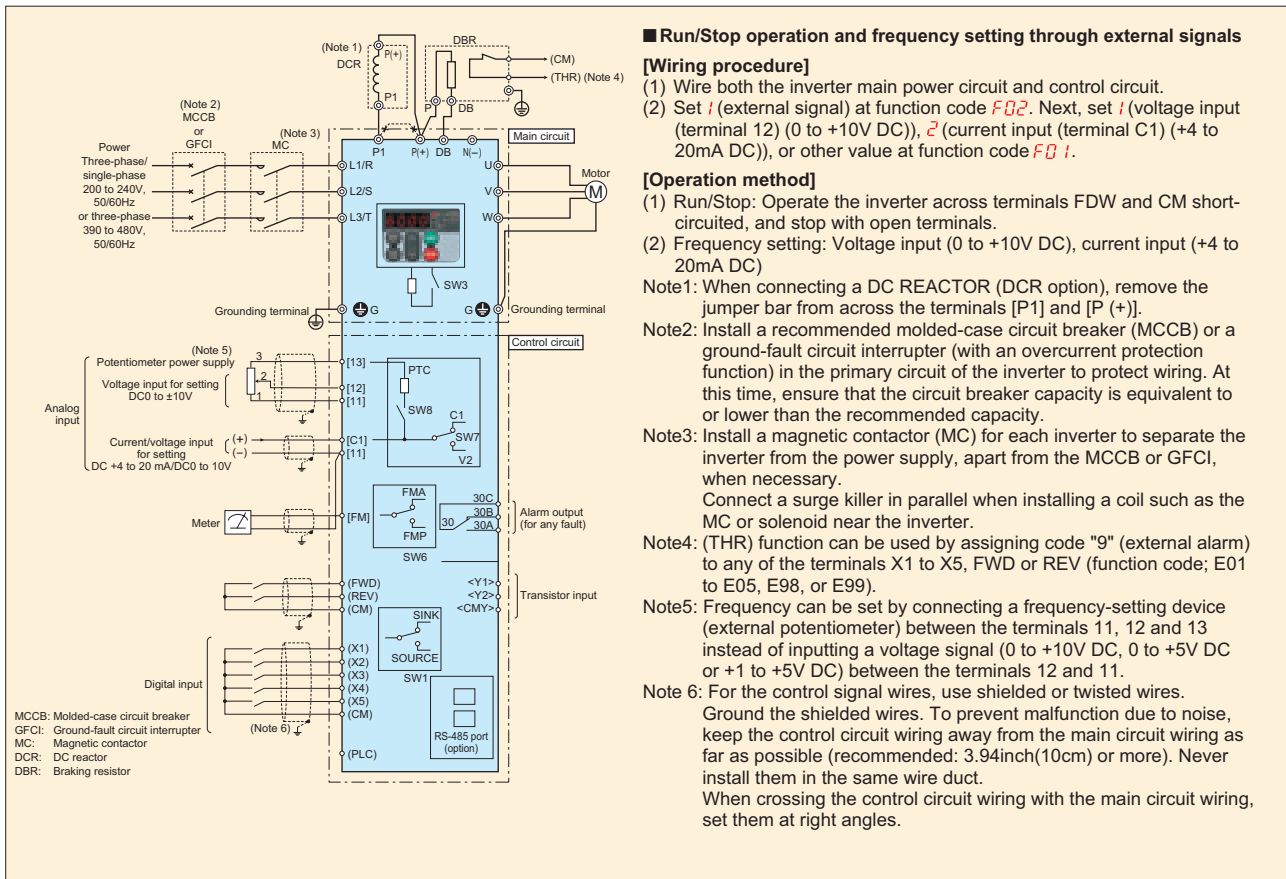

Terminal Functions

Division	Symbol	Terminal name	Functions	Remark	Related function code
Main circuit	L1/R,L2/S,L3/T	Power input	Connect a three-phase power supply.		
	U,V,W	Inverter output	Connect a three-phase motor.		
	P1,P (+)	For DC REACTOR	Connect the DC reactor (DCR).		
	P (+),DB	For braking resistor	Connect the braking resistor (option).		
	P (+),N (-) ⊕ G	For DC bus connection Grounding	Used for DC bus connection. Terminal for inverter chassis (case) and motor grounding	Two terminals are provided.	
Frequency setting	13	Potentiometer power supply	Used for frequency setting device power supply (variable resistance: 1 to 5kΩ) (10V DC 10mA DC max.)	Connect the potentiometer with higher than 1/2W.	
	12	Analog setting voltage input	Used as a frequency setting voltage input.0 to ±10V DC/0 to 100% (0 to ±5V DC/0 to 100%)	Input impedance: 22kΩ Maximum input: +15V DC However, the current larger than ±20mA DC is handled as ±20mA DC.	F18 C32 to C35 E61
		(Inverse operation)	±10 to 0V DC/0 to ±100%		
		(PID control) (Frequency aux. setting)	Used for setting signal (PID process command value) or feedback signal. Used as additional auxiliary setting to various frequency settings.		
	C1	Analog setting current input	Used as a frequency setting current input.4 to 20mA DC/0 to 100%	Input impedance: 250Ω Maximum input: 30mA DC However, the voltage higher than ±10V DC is handled as ±0V DC.	F18 C37 to C39 E62
		(Inverse operation)	20 to 4mA DC/0 to 100%		
		(PID control)	Used for setting signal (PID process command value) or feedback signal.		
		(Frequency aux. setting)	Used as additional auxiliary setting to various frequency settings.		
		(V2)	Analog setting voltage input		
	(Inverse operation)	+10 to 0V DC/0 to 100%			
(PID control) (Frequency aux. setting)	Used for setting signal (PID process command value) or feedback signal. Used as additional auxiliary setting to various frequency settings.				
(PTC) (PTC thermistor)		Connect the thermistor used to protect the motor.		H26, H27	
11	Analog common	Common terminal for frequency setting signals (13, 12, C1, FM)	Two terminals are provided. Isolated from terminals CM and CMY.		
Digital input	X1	Digital input 1	The following functions can be set at terminals X1 to X5, FWD and REV for signal input. <Common function> • Sink and source are changeable using the built-in sliding switch. • ON timing can be changed between short-circuit of terminals X1 and CM and open circuits of them. The same setting is possible between CM and any of the terminals among X2, X3, X4, X5, FWD, and REV.	ON state Source current: 2.5 to 5mA Voltage level: 2V Allowable leakage current: Smaller than 0.5mA Voltage: 22 to 27V	E01 E02 E03 E04 E05 E98 E99
	X2	Digital input 2			
	X3	Digital input 3			
	X4	Digital input 4			
	X5	Digital input 5			
	FWD	Forward operation command			
	REV	Reverse operation command	The motor runs in the forward direction upon ON across (FWD) and CM. The motor decelerates and stops upon OFF. The motor runs in the reverse direction upon ON across (REV) and CM. The motor decelerates and stops upon OFF. 16-step operation can be conducted with ON/OFF signals at (SS1) to (SS8).	This function can be set only for the terminals FWD and REV.	C05 to C19
	(FWD)	Forward operation command			
	(REV)	Reverse operation command			
	(SS1) (SS2) (SS4) (SS8)	Multistep freq. selection			
	(RT1)	Acceleration time selection command	ON across (RT1) and CM: The acceleration time 2 setting is available. OFF across (RT1) and CM: The acceleration time 1 setting is available.		E10, E11 F07, F08
	(HLD)	3-wire operation stop command	Used for 3-wire operation. ON across (HLD) and CM: The inverter self-holds FWD or REV signal. OFF across (HLD) and CM: The inverter releases self-holding.		
	(BX)	Coast-to-stop command	ON across (BX) and CM: The inverter output is shut off immediately and the motor coasts to a stop.	No alarm signal will be output.	
	(RST)	Alarm (error) reset	ON across (RST) and CM: Faults are reset.	Alarm reset signal width: 0.1(s) or more	
	(THR)	Trip command (External fault)	OFF across (THR) and CM: The inverter output is shut off immediately and the motor coasts-to-stop.	Alarm signal OH2 will be output.	
	(Hz2/Hz1)	Freq. set 2/Freq. set 1	ON across (Hz2/Hz1) and CM: Freq. set 2 is effective.		F01, F30
	(M2/M1)	Motor2/Motor1	ON across (M2/M1) and CM: The motor 2 setting is available. OFF across (M2/M1) and CM: The motor 1 setting is available.		A01 to A46 P01 to P99
	(DCBRK)	DC braking command	ON across (DCBRK) and CM: Starts DC braking action.		F20 to F22
	(TL2/TL1)	Torque limit 2/Torque limit 1	ON across (TL2/TL1) and CM: The torque limit 2 setting is available. OFF across (TL2/TL1) and CM: The torque limit 1 setting is available.		E16, E17 F40, F41
	(UP)	UP command	The output frequency rises while the circuit across (UP) and CM is connected.		F01, C30
	(DOWN)	DOWN command	The output frequency drops while the circuit across (DOWN) and CM is connected.		J02
	(WE-KP)	Write enable for KEYPAD (Changing data is available.)	The function code data can be changed from the keypad only when (WE-KP) is ON.		F00
	(Hz/PID)	PID cancel	PID control can be canceled when the circuit across (Hz/PID) and CM is connected. (Operation proceeds according to the selected frequency setting method such as the multi-step frequency, keypad and analog input.)		J01 to J06 J10 to J19
	(IVS)	Inverse mode changeover	The frequency setting or PID control output signal (frequency setting) action mode switches between normal and inverse actions when the circuit across (IVS) and CM is connected.		C50, J01
	(LE)	Link enable	Operation proceeds according to commands sent via RS-485 communication or field bus (option) when the circuit across (LE) and CM are connected.		H30, y98
	(U-DI)	Universal DI	An arbitrary digital input signal is transmitted to the host controller.		
	(STM)	Starting characteristic selection	ON across (STM) and CM: Starting at the pick-up frequency becomes valid.		H17, H09
(STOP)	Forcible stop	OFF across (STOP) and CM: The inverter is forcibly stopped in the special deceleration time.		H56	
(PID-RST)	PID differentiation / integration reset	ON across (PID-RST) and CM: Resets differentiation and integration values of PID.		J01 to J06	
(PID-HLD)	PID integral hold	ON across (PID-HLD) and CM: Holds integration values of PID.		J10 to J19	
(JOG)	Jogging operation	ON across (JOG) and CM: The operation mode enters jogging mode and frequency setting switches to jogging frequency and acceleration and deceleration time for jogging operation.		C20 H54	
PLC	PLC terminal	Connect to PLC output signal power supply. Common for 24V power.	+24V (22 to 27V) 50mA max.		
CM	Digital common	Common terminal for digital input signal	Isolated from terminals 11 and CMY. Two terminals are provided.		

Digital input	0	1	2	3	4	5	6	7	8	9	10	11	12	13	14	15
(SS1)	-	ON	-	ON	-	ON	-	ON	-	ON	-	ON	-	ON	-	ON
(SS2)	-	-	ON	ON	-	-	ON	ON	-	-	ON	ON	-	-	ON	ON
(SS4)	-	-	-	-	ON	ON	ON	ON	-	-	-	-	ON	ON	ON	ON
(SS8)	-	-	-	-	-	-	-	-	ON	ON	ON	ON	ON	ON	ON	ON

Terminal Functions

Division	Symbol	Terminal name	Functions	Remark	Related function code
Analog output	FM (FMA)	Analog monitor	A monitor signal of analog DC voltage between 0 to +10V DC) can be output for the item selected from the following: • Output frequency 1 (before slip compensation) • Output frequency 2 (after slip compensation) • Output current • Output voltage • Output torque • Load factor. • Power consumption • PID feedback value (PV) • DC link circuit voltage • Universal AO. • Motor output • Analog output test. • PID command (SV) • PID output (MV)	Connectable impedance (Minimum impedance: 7.5HP(5kW) in the (0 to +10V DC) In case of voltage output, up to two analog voltmeters (0 to 10V DC, input impedance: 10kΩ) can be connected. Gain adjustment range: 0 to 300%	F29 to F31
	(FMP)	Pulse monitor	One of the following items can be output in a pulse frequency. • Output frequency 1 (before slip compensation) • Output frequency 2 (after slip compensation) • Output current • Output voltage • Output torque • Load factor. • Power consumption • PID feedback value (PV) • DC link circuit voltage • Universal AO • Motor output • Analog output test • PID command (SV) • PID output (MV)	Up to two analog voltmeters (0 to 10V DC, input impedance: 10kΩ) can be connected. (Driven at average voltage)	F29, F31, F33
Transistor output	(PLC)	Transistor output power	Power supply for a transistor output load. (24V DC 50mA DC Max)	• Short circuit across terminals CM and CMY to use. • Same terminal as digital input PLC terminal	E20
	Y1	Transistor output 1	The following functions can be set at terminals Y1 or Y2 for signal output. • The setting of "short circuit upon active signal output" or "open upon active signal output" is possible. • Sink/source support (switching unnecessary)	Max. voltage: 27V DC Max. current: 50mA Leak current: 0.1mA max. ON voltage: within 2V (at 50mA)	E21 E22
	Y2	Transistor output 2			
	(RUN)	Inverter running	An ON signal is output when the inverter runs at higher than the starting frequency.		
	(RUN2)	Inverter output on	A signal is issued when the inverter runs at smaller than the starting frequency or when DC braking is in action.		
	(FAR)	Speed/freq. arrival	An active signal is issued when the output frequency reaches the set frequency.	Detection width: 0 to 10.0 [Hz]	E30
	(FDT)	Speed/freq. detection	An ON signal is output at output frequencies above a preset detection level. The signal is deactivated if the output frequency falls below the detection level.	Operation level: 0.0 to 400.0 [Hz] Hysteresis width: 0.0 to 400.0 [Hz]	E31 E32
	(LV)	Undervoltage detection	The signal is output when the inverter stops because of undervoltage.		
	(B/D)	Torque polarity detection	The OFF signal is output when the inverter is running in drive mode and the ON signal is output in the braking mode or stopped state.		
	(IOL)	Inverter output limit (limit on current)	The signal is output when the inverter is limiting the current.		F43, F44
	(IPF)	Auto-restarting	The signal is output during auto restart operation (after momentary power failure and until completion of restart).		F14
	(OL)	Overload early warning (motor)	The signal is output when the electronic thermal relay value is higher than the preset alarm level.		F10 to F12
	(RDY)	Operation ready output	A signal is issued if preparation for inverter operation is completed.		
	(SWM2)	Motor 2 switching	The motor switching signal (M2/M1) is input and the ON signal is output when the motor 2 is selected.		
	(TRY)	Retry in action	The signal is output during an active retry.		H04, H05
	(OH)	Heat sink overheat early warning	An early warning signal is issued before the heat sink trips due to overheat.		
	(FAR2)	Frequency arrival 2	The signal is output when the time set in E29 elapses after the frequency arrival signal (FAR) is output.		E29
	(IOL2)	Inverter output limit	If more than 20ms elapse while one of the following operations is operating: current limiter for the inverter, automatic deceleration operation or torque limiter.		F41 to F44 H69
	(LIFE)	Lifetime alarm	Outputs alarm signal according to the preset lifetime level.		H42, H43, H88
	(REF OFF)	Command loss detection	A loss of the frequency command is detected.		E65
	(OLP)	Overload preventive control	The signal is output when the overload control is activated.		H70
	(ID)	Current detection	The signal is output when a current larger than the set value has been detected for the timer-set time.		E34, E35
	(ID2)	Current detection 2	The signal is output when a current larger than the set value 2 has been detected for the timer-set time.		E37, E38
	(PID-ALM)	PID alarm output	An absolute value alarm or deviation alarm under PID control is issued as a signal.		J11 to J13
	(BRKS)	Brake signal	The signal for enabling or releasing the brake is output.		J68 to J72
	(ALM)	Alarm relay output (for any fault)	An alarm relay output (for any fault) signal is issued as a transistor output signal.		
	CMY	Transistor output common	Common terminal for transistor output	The terminal is isolated from terminals 11 and CM.	
Contact output	30A,30B,30C	Alarm relay output (for any fault)	• A no-voltage contact signal (1c) is issued when the inverter is stopped due to an alarm. • Multi-purpose relay output; signals similar to above-mentioned signals Y1 to Y2 can be selected. • An alarm output is issued upon either excitation or no excitation according to selection.	Contact capacity: 250V AC, 0.3A, cosφ=0.3, +48V DC, 0.5A	E27
Communication	—	RJ-45 connector for connection of keypad	One of the following protocols can be selected. • Protocol exclusively for keypad (default selection) • Modbus RTU • Fuji's special inverter protocol • SX protocol for PC loader	Power (+5V) is supplied to the keypad.	H30 y01 to y20 y98, y99

Terminal Arrangement

Main circuit terminals

Power source	Applied motor [HP]	Inverter type	Fig.
Three-phase 230V	1/8	FRNF12E1□-2U	Fig. A
	1/4	FRNF25E1□-2U	
	1/2	FRNF50E1□-2U	
	1	FRN001E1□-2U	
	2	FRN002E1□-2U	Fig. B
	3	FRN003E1□-2U	
	5	FRN005E1□-2U	Fig. C
	7.5	FRN007E1□-2U	
10	FRN010E1□-2U		
15	FRN015E1□-2U		
Three-phase 460V	1/2	FRNF50E1□-4U	Fig. B
	1	FRN001E1□-4U	
	2	FRN002E1□-4U	
	3	FRN003E1□-4U	
	5	FRN005E1□-4U	Fig. C
	7.5	FRN007E1□-4U	
	10	FRN010E1□-4U	
	15	FRN015E1□-4U	
Single-phase 230V	1/8	FRNF12E1□-7U	Fig. D
	1/4	FRNF25E1□-7U	
	1/2	FRNF50E1□-7U	
	1	FRN001E1□-7U	Fig. E
	2	FRN002E1□-7U	
	3	FRN003E1□-7U	

The code in □ represents followings:
 S: standard model, E: EMC filter built-in type

Fig. A

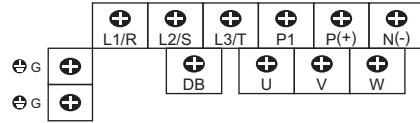

Fig. B

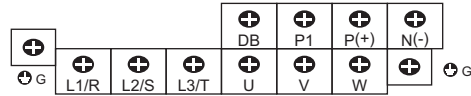

Fig. C

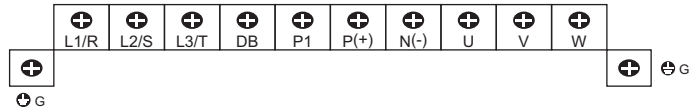

Fig. D

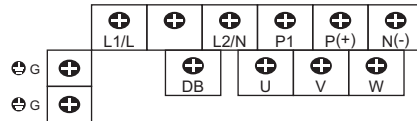
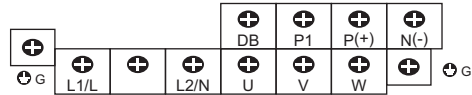
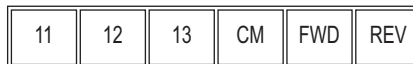

Fig. E



Control circuit terminals (common to all the inverter models)



Terminal size: M3

Protective Functions		Description	LED indication	Alarm output (30A, B, C) Note	Related function code
Overcurrent protection		The inverter is stopped for protection against overcurrent.	During acceleration <i>OC1</i>	○	
Short circuit protection		The inverter is stopped for protection against overcurrent caused by a short circuit in the output circuit.	During deceleration <i>OC2</i>	○	
Grounding fault protection		The inverter is stopped upon start-up for protection against overcurrent caused by a grounding fault in the output circuit. If the power supply is turned on with the grounding fault, the inverter and the controlled equipment may not be protected.	During constant speed operation <i>OC3</i>	○	
Overvoltage protection		An excessive voltage (3-phase and Single-phase 230V series: 400V DC, 3-phase 460V series: 800V DC) in the DC link circuit is detected and the inverter is stopped. If an excessive voltage is applied by mistake, the protection cannot be guaranteed.	During acceleration <i>OU1</i> During deceleration <i>OU2</i> During constant speed operation <i>OU3</i>	○	
Undervoltage protection		The voltage drop (3-phase 230V series: 200V DC, 3-phase 460V series: 400V DC) in the DC link circuit is detected to stop the inverter. However, when "F14: 3, 4 or 5" is selected, an alarm is not issued even upon a voltage drop in the DC link circuit.	<i>LU</i>	△	F14
Input phase loss protection		The input phase loss is detected to shut off the inverter output. This function protects the inverter from being damaged by adding extreme stress caused by a power phase loss or imbalance between phases. When the load to be connected is small or DC REACTOR is connected a phase loss is not detected.	<i>Lin</i>	○	H98
Output phase loss protection		Detects breaks in inverter output wiring at the start of operation and during running, to shut off the inverter output.	<i>OPL</i>	○	H98
Overheating protection		Stops the inverter output upon detecting excess heat sink temperature in case of cooling fan failure or overload.	<i>OH1</i>	○	H43, H98
		Discharging and inverter operation are stopped due to overheating of an external braking resistor. * Function codes must be set corresponding to the braking resistor.	<i>dbH</i>	○	
Overload protection		The temperature inside the IGBT is calculated from the detection of output current and internal temperature, to shut off the inverter output.	<i>OLU</i>	○	
External alarm input		With the digital input signal (THR) opened, the inverter is stopped with an alarm.	<i>OH2</i>	○	E01 to E05 E98, E99
Motor protection	Electronic thermal	The inverter is stopped with an electronic thermal function set to protect the motor. • The standard motor is protected at all the frequencies. • The inverter motor is protected at all the frequencies. *The operation level and thermal time constant can be set.	<i>OL1</i> <i>OL2</i>	○	F10,A06 F11,F12,A07,A08
	PTC thermistor	A PTC thermistor input stops the inverter to protect the motor. • The PTC thermistor is connected between terminals C1 and 11 to set switches and function codes on the control PC board.	<i>OH4</i>	○	H26,H27
	Overload early warning	Warning signal is output at the predetermined level before stopping the inverter with the electronic thermal function to protect the motor.	—	—	E34,E35
Stall prevention		This is protected when the instantaneous overcurrent limit works. • Instantaneous overcurrent limit: Operates when the inverter output current goes beyond the instantaneous overcurrent limiting level, and avoids tripping (during acceleration and constant speed operation).	—	—	H12
Alarm relay output (for any fault)		The relay signal is output when the inverter stops upon an alarm. <Alarm reset> The key or digital input signal (RST) is used to reset the alarm stop state. <Storage of alarm history and detailed data> Up to the last 4 alarms can be stored and displayed.	—	○	E20,E21,E27 E01 to E05 E98,E99
Memory error		Data is checked upon power-on and data writing to detect any fault in the memory and to stop the inverter if any.	<i>Er1</i>	○	
Keypad communication error		The keypad (standard) or multi-function keypad (optional) is used to detect a communication fault between the keypad and inverter main body during operation and to stop the inverter.	<i>Er2</i>	○	F02
CPU error		Detects a CPU error or LSI error caused by noise.	<i>Er3</i>	○	
Option communication error		When each option card is used, a fault of communication with the inverter main body is detected to stop the inverter.	<i>Er4</i>	—	
Option error		When each option card is used, the option card detects a fault to stop the inverter.	<i>Er5</i>	—	
Operation error	STOP key priority:	Pressing the key on the keypad or entering the digital input signal will forcibly decelerate and stop the motor even if the operation command through signal input or communication is selected.	<i>Er6</i>	○	H96
	Start check:	Start check: If the operation command is entered in the following cases, <i>Er6</i> will be displayed on the LED monitor to prohibit operation. • Power-on • Alarm reset (key ON or alarm (error) reset [RST] is reset.) • The link operation selection "LE" is used to switch operation.			
Tuning error		When tuning failure, interruption, or any fault as a result of tuning is detected while tuning for motor constant.	<i>Er7</i>	○	P04
RS-485 communication error		When the connection port of the keypad connected via RS-485 communication port to detect a communication error, the inverter is stopped and displays an error.	<i>Er8</i>	○	
Data save error upon Undervoltage		When the undervoltage protection works, an error is displayed if data cannot be stored.	<i>ErF</i>	○	
RS-485 communication error (optional)		When an optional RS-485 communication card is used to configure the network, a fault of communication with the inverter main body is detected to stop the inverter.	<i>ErP</i>	○	
Retry		When the inverter is tripped and stopped, this function automatically resets the tripping state and restarts operation. (The number of retries and the length of wait before resetting can be set.)	—	—	H04,H05
Surge protection		The inverter is protected against surge voltage intruding between the main circuit power line and ground.	—	—	
Command loss detection		A loss (broken wire, etc.) of the frequency command is detected to output an alarm and continue operation at the preset frequency (set at a ratio to the frequency before detection).	—	—	E65
PG disconnection		An error displays when the signal line for PG is disconnected while the PG feedback card is installed.	<i>PG</i>	○	
Momentary power failure protection		• A protective function (inverter stoppage) is activated upon a momentary power failure for 15msec or longer.	—	—	F14 H13 to H16
		• If restart upon momentary power failure is selected, the inverter restarts upon recovery of the voltage within the set time.			
Overload avoidance control		The inverter output frequency is reduced to avoid tripping before heat sink overheating or tripping due to an overload (alarm indication: <i>OH1</i> or <i>OLU</i>).	—	—	H70
Hardware error		The inverter is stopped when poor connection between the control board and power source board or interface board, or short-circuit between terminals between 13 and 11 is detected.	<i>ErH</i>	○	
Simulation error		Simulated alarm is output to check the fault sequence.	<i>Err</i>	○	H45

Note: The item indicated with △ in the alarm output (30A, B, C) column may not be issued according to some function code settings.

Terminal Functions
Protective Functions

Function Settings

F codes: Fundamental Functions

Func. Code	Name	Data setting range	Min.	Unit	Data copy ²	Default setting
F00	Data Protection	0: Disable both data protection and digital reference protection 1: Enable data protection and disable digital reference protection 2: Disable data protection and enable digital reference protection 3: Enable both data protection and digital reference protection	—	—	Y	0
F01	Frequency Command 1	0: / keys on keypad 1: Voltage input to terminal [12] (-10 to +10 VDC) 2: Current input to terminal [C1] (C1 function) (4 to 20 mA DC) 3: Sum of voltage and current inputs to terminals [12] and [C1] (C1 function) 5: Voltage input to terminal [C1] (V2 function) (0 to 10 VDC) 7: Terminal command UP /DOWN control 11: Digital input (option) 12: Pulse input (option)	—	—	Y	0
F02	Operation Method	0: RUN/STOP keys on keypad (Motor rotational direction specified by terminal command FWD/REV) 1: Terminal command FWD or REV 2: RUN/STOP keys on keypad (forward) 3: RUN/STOP keys on keypad (reverse)	—	—	Y	2
F03	Maximum Frequency 1	25.0 to 400.0	0.1	Hz	Y	60.0
F04	Base Frequency 1	25.0 to 400.0	0.1	Hz	Y	60.0
F05	Rated Voltage at Base Frequency 1	0: Output a voltage in proportion to input voltage 80 to 240: Output an AVR-controlled voltage (for 230 V class series) 160 to 500: Output an AVR-controlled voltage (for 460 V class series)	1	V	Y2	230 460
F06	Maximum Output Voltage 1	80 to 240: Output an AVR-controlled voltage (for 230 V class series) 160 to 500: Output an AVR-controlled voltage (for 460 V class series)	1	V	Y2	230 460
F07	Acceleration Time 1	0.00 to 3600 Note: Entering 0.00 cancels the acceleration time, requiring external soft-start.	0.01	s	Y	6.00
F08	Deceleration Time 1	0.00 to 3600 Note: Entering 0.00 cancels the deceleration time, requiring external soft-start.	0.01	s	Y	6.00
F09	Torque Boost 1	0.0 to 20.0 (percentage with respect to "F05: Rated Voltage at Base Frequency 1") Note: This setting takes effect when F37 = 0, 1, 3, or 4.	0.1	%	Y	Depending on the inverter capacity
F10	Electronic Thermal Overload Protection for Motor 1 (Select motor characteristics)	1: For a general-purpose motor with shaft-driven cooling fan 2: For an inverter-driven motor, non-ventilated motor, or motor with separately powered cooling fan	—	—	Y	1
F11	(Overload detection level)	0.00: Disable to 135% of the rated current (allowable continuous drive current) of the motor	0.01	A	Y1Y2	100% of the motor rated current
F12	(Thermal time constant)	0.5 to 75.0	0.1	min	Y	5.0
F14	Restart Mode after Momentary Power Failure (Mode selection)	0: Disable restart (Trip immediately) 1: Disable restart (Trip after a recovery from power failure) 4: Enable restart (Restart at the frequency at which the power failure occurred, for general loads) 5: Enable restart (Restart at the starting frequency, for low-inertia load)	—	—	Y	0
F15	Frequency Limiter (High)	0.0 to 400.0	0.1	Hz	Y	70.0
F16	(Low)	0.0 to 400.0	0.1	Hz	Y	0.0
F18	Bias (Frequency command 1)	-100.00 to 100.00 *1	0.01	%	Y	0.00
F20	DC (Braking starting frequency)	0.0 to 60.0	0.1	Hz	Y	0.0
F21	Braking 1 (Braking level)	0 to 100	1	%	Y	0
F22	(Braking time)	0.00 : Disable 0.01 to 30.00	0.01	s	Y	0.00
F23	Starting Frequency 1	0.1 to 60.0	0.1	Hz	Y	0.5
F24	(Holding time)	0.01 to 10.00	0.01	s	Y	0.00
F25	Stop Frequency	0.1 to 60.0	0.1	Hz	Y	0.2
F26	Motor Sound (Carrier frequency)	0.75 to 15	1	kHz	Y	2
F27	(Tone)	0 : Level 0 (Inactive) 1 : Level 1 2 : Level 2 3 : Level 3	—	—	Y	0
F29	Analog Output [FM] (Mode selection)	0 : Output in voltage (0 to 10 VDC) [FMA] 2 : Output in pulse (0 to 6000p/s) [FMP]	—	—	Y	0
F30	(Voltage adjustment)	0 to 300 [FMA]	1	%	Y	100
F31	(Function)	Select a function to be monitored from the followings. 0: Output frequency 1 (before slip compensation) 1: Output frequency 2 (after slip compensation) 2: Output current 3: Output voltage 4: Output torque 5: Load factor 6: Input power 7: PID feedback amount (PV) 8: PG feedback value 9: DC link bus voltage 10: Universal AO 13: Motor output 14: Calibration 15: PID command (SV) 16: PID output (MV)	—	—	Y	0
F33	(Pulse rate)	25 to 6000 (FMP, Pulse rate at 100% output)	1	p/s	Y	1440
F37	Load Selection/ Auto Torque Boost / Auto Energy Saving Operation 1	0: Variable torque load 1: Constant torque load 2: Auto-torque boost 3: Auto-energy saving operation (Variable torque load during ACC/DEC) 4: Auto-energy saving operation (Constant torque load during ACC/DEC) 5: Auto-energy saving operation (Auto-torque boost during ACC/DEC)	—	—	Y	1
F39	Stop Frequency (Holding Time)	0.00 to 10.00	0.01	s	Y	0.00
F40	Torque (Limiting Level for driving)	20 to 200 999 : Disable	1	%	Y	999
F41	Limiter 1 (Limiting Level for braking)	20 to 200 999 : Disable	1	%	Y	999
F42	Control Mode Selection 1	0: V/f control with slip compensation inactive 1: Dynamic torque vector control 2: V/f control with slip compensation active 3: V/f control with PG 4: Dynamic torque vector control with PG	—	—	Y	0

● F codes: Fundamental Functions

Func. Code	Name	Data setting range	Min.	Unit	Data copy*2	Default setting
F43	Current Limiter (Mode selection)	0: Disable (No current limiter works.) 1: Enable at constant speed (Disable during ACC/DEC) 2: Enable during ACC/constant speed operation	—	—	Y	2
F44	(Level)	20 to 200 (The data is interpreted as the rated output current of the inverter for 100%.)	1	%	Y	180
F50	Electronic Thermal Overload Protection (Discharging capability)	1 to 900 999: Disable 0: Reserved	1	kWs	Y	999
F51	for braking resistor (Allowable average loss)	0.001 to 50.000 0.000: Reserved	0.001	kW	Y	0.000

● E codes: Extension Terminal Functions

Func. Code	Name	Data setting range	Min.	Unit	Data copy*2	Default setting
E01	Terminal X1 function	Selecting function code data assigns the corresponding function to terminals [X1] to [X5] as listed below.	—	—	Y	0
E02	Terminal X2 function	0 (1000) : Select multi-frequency [SS1]	—	—	Y	1
E03	Terminal X3 function	1 (1001) : Select multi-frequency [SS2]	—	—	Y	2
E04	Terminal X4 function	2 (1002) : Select multi-frequency [SS4]	—	—	Y	7
E05	Terminal X5 function	3 (1003) : Select multi-frequency [SS8] 4 (1004) : Select ACC/DEC time [RT1] 6 (1006) : Enable 3-wire operation [HLD] 7 (1007) : Coast to a stop [BX] 8 (1008) : Reset alarm [RST] 9 (1009) : Enable external alarm trip [THR] 10 (1010) : Ready for jogging [JOG] 11 (1011) : Select frequency command 2/1 [Hz2/Hz1] 12 (1012) : Select motor 2/motor 1 [M2/M1] 13 : Enable DC braking [DCBRK] 14 (1014) : Select torque limiter level [TL2/TL1] 17 (1017) : UP (Increase output frequency) [UP] 18 (1018) : DOWN (Decrease output frequency) [DOWN] 19 (1019) : Enable data change with keypad [WE-KP] 20 (1020) : Cancel PID control [Hz/PID] 21 (1021) : Switch normal/inverse operation [IVS] 24 (1024) : Enable communications link via RS-485 or field bus [LE] 25 (1025) : Universal DI [U-DI] 26 (1026) : Enable auto search for idling motor speed at starting [STM] 27 (1027) : Speed feedback control switch [PG/Hz] 30 (1030) : Force to stop [STOP] 33 (1033) : Reset PID integral and differential components [PID-RST] 34 (1034) : Hold PID integral component [PID-HLD] 42 (1042) : Position control limit switch [LS] 43 (1043) : Position control start/reset command [SR] 44 (1044) : Serial pulse Receive mode [SPRM] 45 (1045) : Position Control return mode [RTN] 46 (1046) : Overload stopping effective command [OLS]	—	—	Y	8
Setting the value of 1000s in parentheses () shown above assigns a negative logic input to a terminal. Note: In the case of THR and STOP, data (1009) and (1030) are for normal logic, and "9" and "30" are for negative logic, respectively.						
E10	Acceleration Time 2	0.00 to 3600 Note: Entering 0.00 cancels the acceleration time, requiring external soft-start.	0.01	s	Y	10.0
E11	Deceleration Time 2	0.00 to 3600 Note: Entering 0.00 cancels the acceleration time, requiring external soft-start.	0.01	s	Y	10.0
E16	Torque Limiter 1 (Limiting Level for driving)	20 to 200 999 : Disable	1	%	Y	999
E17	Limiters 2 (Limiting Level for braking)	20 to 200 999 : Disable	1	%	Y	999
E20	Terminal [Y1] Function	Selecting function code data assigns the corresponding function to terminals [Y1], [Y2], and [30A/B/C] as listed below.	—	—	Y	0
E21	Terminal [Y2] Function	0 (1000) : Inverter running [RUN]	—	—	Y	7
E22	Terminal [30A/B/C] Function	1 (1001) : Frequency arrival signal [FAR] 2 (1002) : Frequency detected [FDT] 3 (1003) : Undervoltage detected (Inverter stopped) [LU] 4 (1004) : Torque polarity detected [B/D] 5 (1005) : Inverter output limiting [IOL] 6 (1006) : Auto-restarting after momentary power failure [IPF] 7 (1007) : Motor overload early warning [OL] 10 (1010) : Inverter ready to run [RDY] 21 (1021) : Frequency arrival signal 2 [FAR2] 22 (1022) : Inverter output limiting with delay [IOL2] 26 (1026) : Auto-resetting [TRY] 28 (1028) : Heat sink overheat early warning [OH] 30 (1030) : Service lifetime alarm [LIFE] 33 (1033) : Reference loss detected [REF OFF] 35 (1035) : Inverter output on [RUN2] 36 (1036) : Overload prevention control [OLP] 37 (1037) : Current detected [ID] 38 (1038) : Current detected 2 [ID2] 42 (1042) : PID alarm [PID-ALM] 49 (1049) : Switched to motor 2 [SWM2] 57 (1057) : Brake signal [BRKS] 76 (1076) : PG error signal [PG-ERR] 80 (1080) : Over traveling [OT] 81 (1081) : Time up of the start timer or the end timer [TO] 82 (1082) : Completion of positioning [PSET] 83 (1083) : Current position pulse overflow [POF] 99 (1099) : Alarm output (for any alarm) [ALM]	—	—	Y	99
Setting the value of 1000s in parentheses () shown above assigns a negative logic input to a terminal.						

*1 When you make settings from the keypad, the incremental unit is restricted by the number of digits that the LED monitor can display.
(Example) If the setting range is from -200.00 to 200.00, the incremental unit is as follows:
"1" for -200 to -100, "0.1" for -99.9 to -10.0, "0.01" for -9.99 to -0.01, "0.01" for 0.00 to 99.99, and "0.1" for 100.0 to 200.0
*2 Symbols in the "Data copy" column
Y: Will be copied unconditionally.
Y1: Will not be copied if the rated capacity differs from the source inverter.

Y2: Will not be copied if the rated input voltage differs from the source inverter.
N: Will not be copied.
*3 Reserved for the maker. Do not set any data.
<Changing, validating, and saving function code data when the motor is running>
□: Impossible, ◻: Possible (Change data with ⏏⏏ keys and then save/validate it with ⏏ key), ◻: Possible (Change and validate data with ⏏⏏ keys and then save it with ⏏ key)

Function Settings

■ Functions Settings

● E codes: Extension Terminal Functions

Func. Code	Name	Data setting range	Min.	Unit	Data copy ²	Default setting
E29	Frequency Arrival Delay Time	0.01 to 10.00	0.01	s	Y	0.10
E30	Frequency Arrival (hysteresis width)	0.0 to 10.0	0.1	Hz	Y	2.5
E31	Frequency Detection (FDT) (Detection level)	0.0 to 400.0	0.1	Hz	Y	60.0
E32	(hysteresis width)	0.0 to 400.0	0.1	Hz	Y	1.0
E34	Overload Early Warning /Current Detection (Level)	0.00 : Disable Current value of 1 to 200% of the inverter rated current	0.01	A	Y1Y2	100% of the motor rated current
E35	(Timer)	0.01 to 600.00 *1	0.01	s	Y	10.00
E37	Current detection 2 (Level)	0.00 : Disable Current value of 1 to 200% of the inverter rated current	0.01	A	Y1Y2	100% of the motor rated current
E38	(Timer)	0.01 to 600.00 *1	0.01	s	Y	10.00
E39	Coefficient for Constant Feeding Rate Time	0.000 to 9.999	0.001	—	Y	0.000
E40	PID Display Coefficient A	-999 to 0.00 to 9990 *1	0.01	—	Y	100
E41	B	-999 to 0.00 to 9990 *1	0.01	—	Y	0.00
E42	LED Display filter	0.0 to 5.0	0.1	s	Y	0.5
E43	LED Monitor (Item selection)	0: Speed monitor (select by E48) 3: Output current 4: Output voltage 8: Calculated torque 9: Input power 10: PID command 12: PID feedback amount 13: Timer 14: PID output 15: Load factor 16: Motor output 21: Present pulse position 22: Deviation of pulse position	—	—	Y	0
E45	LCD Monitor *4 (Item selection)	0: Running status, rotational direction and operation guide 1: Bar charts for output frequency, current and calculated torque	—	—	Y	0
E46	(Language selection)	0 : Japanese 1 : English 2 : German 3 : French 4 : Spanish 5 : Italian	—	—	Y	1
E47	(Contrast control)	0 (Low) to 10 (High)	1	—	Y	5
E48	LED Monitor (Speed monitor item)	0: Output frequency (Before slip compensation) 1: Output frequency (After slip compensation) 2: Reference frequency 3: Motor speed in r/min 4: Load shaft speed in r/min 5: Line speed in m/min 6: Constant feeding rate time	—	—	Y	0
E50	Coefficient for Speed Indication	0.01 to 200.00 *1	0.01	—	Y	30.00
E51	Display Coefficient for Input Watt-hour Data	0.000 (Cancel/reset) 0.001 to 9999	0.001	—	Y	0.010
E52	Keypad (Menu display mode)	0: Function code data editing mode (Menus #0 and #1) 1: Function code data check mode (Menu #2) 2: Full-menu mode (Menus #0 through #6)	—	—	Y	0
E59	Terminal [C1] Signal Definition (C1/V2 Function)	0: Current input (C1 function), 4 to 20 mADC 1: Voltage input (V2 function), 0 to +10 VDC	—	—	Y	0
E61	Terminal [12] Extended Function	Selecting function code data assigns the corresponding function to terminals [12] and [C1] (C1/V2 function) as listed below.	—	—	Y	0
E62	Terminal [C1] Extended Function (C1 function)	0: None	—	—	Y	0
E63	Terminal [C1] Extended Function (V2 function)	1: Auxiliary frequency command 1 2: Auxiliary frequency command 2 3: PID command 1 5: PID feedback amount	—	—	Y	0
E65	Reference Loss Detection (Continuous running frequency)	0: Decelerate to stop 20 to 120 999: Disable	1	%	Y	999
E98	Terminal [FWD] Function	Selecting function code data assigns the corresponding function to terminals [FWD] and [REV] as listed below.	—	—	Y	98
E99	Terminal [REV] Function	0 (1000) : Select multi-frequency [SS1] 1 (1001) : Select multi-frequency [SS2] 2 (1002) : Select multi-frequency [SS4] 3 (1003) : Select multi-frequency [SS8] 4 (1004) : Select ACC/DEC time [RT1] 6 (1006) : Enable 3-wire operation [HLD] 7 (1007) : Coast to a stop [BX] 8 (1008) : Reset alarm [RST] 9 (1009) : Enable external alarm trip [THR] 10 (1010) : Ready for jogging [JOG] 11 (1011) : Select frequency command 2/1 [Hz2/Hz1] 12 (1012) : Select motor 2/motor 1 [M2/M1] 13 : Enable DC braking [DCBRK] 14 (1014) : Select torque limiter level [TL2/TL1] 17 (1017) : UP (Increase output frequency) [UP] 18 (1018) : DOWN (Decrease output frequency) [DOWN] 19 (1019) : Enable data change with keypad [WE-KP] 20 (1020) : Cancel PID control [Hz/PID] 21 (1021) : Switch normal/inverse operation [IVS] 24 (1024) : Enable communications link via RS-485 or field bus [LE] 25 (1025) : Universal DI [U-DI] 26 (1026) : Enable auto search for idling motor speed at starting [STM] 27 (1027) : Speed feedback control switch [PG/Hz] 30 (1030) : Force to stop [STOP] 33 (1033) : Reset PID integral and differential components [PID-RST] 34 (1034) : Hold PID integral component [PID-HLD]	—	—	Y	99

●E codes: Extension Terminal Functions

Func. Code	Name	Data setting range	Min.	Unit	Data copy ^{*2}	Default setting
		42 (1042) : Position limit switch [LS] 43 (1043) : Position control start/reset command [S/R] 44 (1044) : Serial pulse Receive mode [SPRM] 45 (1045) : Position Control return mode [RTN] 46 (1046) : Overload stopping effective command [OLS] 98 : Run forward [FWD] 99 : Run reverse [REV] Setting the value of 1000s in parentheses () shown above assigns a negative logic input to a terminal. Note: In the case of THR and STOP, data (1009) and (1030) are for normal logic, and "9" and "30" are for negative logic, respectively.				

●C codes: Control Functions

Func. Code	Name	Data setting range	Min.	Unit	Data copy ^{*2}	Default setting
E01	Jump Frequency 1	0.0 to 400.0	0.1	Hz	Y	0.00
E02	2				Y	0.00
E03	3				Y	0.00
E04	(Hysteresis width)	0.0 to 30.0	0.1	Hz	Y	3.0
E05	Multi-Frequency 1	0.00 to 400.00	0.01	Hz	Y	0.00
E06	2				Y	0.00
E07	3				Y	0.00
E08	4				Y	0.00
E09	5				Y	0.00
E10	6				Y	0.00
E11	7				Y	0.00
E12	8				Y	0.00
E13	9				Y	0.00
E14	10				Y	0.00
E15	11				Y	0.00
E16	12				Y	0.00
E17	13				Y	0.00
E18	14				Y	0.00
E19	15				Y	0.00
E20	Jogging Frequency	0.00 to 400.00	0.01	Hz	Y	0.00
E21	Timer Operation	0 : Disable 1 : Enable	-	-	Y	0
E30	Frequency Command 2	0 : / keys on keypad 1: Voltage input to terminal [12] (-10 to +10 VDC) 2: Current input to terminal [C1] (C1 function) (4 to 20 mA DC) 3: Sum of voltage and current inputs to terminals [12] and [C1] (C1 function) 5: Voltage input to terminal [C1] (V2 function) (0 to 10 VDC) 7: Terminal command UP / DOWN control 11: Digital input (option) 12: Pulse input (option)	-	-	Y	2
E31	Analog Input Adjustment (offset) for [12]	-5.0 to 5.0	0.1	%	Y	0.0
E32	(Gain)	0.00 to 200.00 *1	0.01	%	Y	100.0
E33	(Filter time constant)	0.00 to 5.00	0.01	s	Y	0.05
E34	(Gain base point)	0.00 to 100.00 *1	0.01	%	Y	100.0
E35	(Polarity)	0 : Bipolar 1 : Unipolar	-	-	Y	1
E36	Analog Input Adjustment (offset) for [C1] (C1 function)	-5.0 to 5.0	0.1	%	Y	0.0
E37	(Gain)	0.00 to 200.00 *1	0.01	%	Y	100.0
E38	(Filter time constant)	0.00 to 5.00	0.01	s	Y	0.05
E39	(Gain base point)	0.00 to 100.00 *1	0.01	%	Y	100.0
E41	Analog Input Adjustment (offset) for [C1] (V2 function)	-5.0 to 5.0	0.1	%	Y	0.0
E42	(Gain)	0.00 to 200.00 *1	0.01	%	Y	100.0
E43	(Filter time constant)	0.00 to 5.00	0.01	s	Y	0.05
E44	(Gain base point)	0.00 to 100.00 *1	0.01	%	Y	100.0
E50	Bias (Frequency command 1) (Bias base point)	0.00 to 100.00 *1	0.01	%	Y	0.00
E51	Bias (PID command 1) (Bias value)	-100.00 to 100.00 *1	0.01	%	Y	0.00
E52	(Bias base point)	0.00 to 100.00 *1	0.01	%	Y	0.00
E53	Selection of Normal/Inverse Operation (Frequency command 1)	0 : Normal operation 1 : Inverse operation	-	-	Y	0

*1 When you make settings from the keypad, the incremental unit is restricted by the number of digits that the LED monitor can display.
(Example) If the setting range is from -200.00 to 200.00, the incremental unit is as follows:
"1" for -200 to -100, "0.1" for -99.9 to -10.0, "0.01" for -9.99 to -0.01, "0.01" for 0.00 to 99.99, and "0.1" for 100.0 to 200.0

*2 Symbols in the "Data copy" column
Y: Will be copied unconditionally.
Y1: Will not be copied if the rated capacity differs from the source inverter.
Y2: Will not be copied if the rated input voltage differs from the source inverter.
N: Will not be copied.

*3 Reserved for the maker. Do not set any data.

*4 Use these functions by connection with the multi-tasking keypad (optional).
<Changing, validating, and saving function code data when the motor is running>
: Impossible, : Possible (Change data with / keys and then save/validate it with key), : Possible (Change and validate data with / keys and then save it with key)

Functions Settings

●P codes: Motor Parameters

Func. Code	Name	Data setting range	Min.	Unit	Data copy ²	Default setting
P01	Motor 1 (No. of poles)	2 to 22	2	Pole	Y1Y2	4
P02	(Rated capacity)	0.01 to 30.00 (where, P99 data is 0, 3, or 4.)	0.01	kW	Y1Y2	Rated capacity of motor
		0.01 to 30.00 (where, P99 data is 1.)	0.01	HP		
P03	(Rated current)	0.00 to 100.0	0.01	A	Y1Y2	Rated value of Fuji standard motor
P04	(Auto-tuning)	0: Disable 1: Enable (Tune %R1 and %X while the motor is stopped.) 2: Enable (Tune %R1, %X and rated slip while the motor is stopped, and no-load current while running.)	—	—	N	0
P05	(Online tuning)	0: Disable 1: Enable	—	—	Y	0
P06	(No-load current)	0.00 to 50.00	0.01	A	Y1Y2	Rated value of Fuji standard motor
P07	(%R1)	0.00 to 50.00	0.01	%	Y1Y2	Rated value of Fuji standard motor
P08	(%X)	0.00 to 50.00	0.01	%	Y1Y2	Rated value of Fuji standard motor
P09	(Slip compensation gain for driving)	0.0 to 200.0	0.01	%	Y	100.0
P10	(Slip compensation response time)	0.00 to 10.00	0.01	s	Y1Y2	0.50
P11	(Slip compensation gain for braking)	0.0 to 200.0	0.01	%	Y	100.0
P12	(Rated slip frequency)	0.00 to 15.00	0.01	Hz	Y1Y2	Rated value of Fuji standard motor
P99	Motor 1 Selection	0: Motor characteristics 0 (Fuji standard motors, 8-series) 1: Motor characteristics 1 (HP rating motors) 3: Motor characteristics 3 (Fuji standard motors, 6-series) 4: Other motors	—	—	Y1Y2	0

●H codes: High Performance Functions

Func. Code	Name	Data setting range	Min.	Unit	Data copy ²	Default setting
H03	Data Initialization	0: Disable initialization 1: Initialize all function code data to the factory defaults 2: Initialize motor 1 parameters 3: Initialize motor 2 parameters	—	—	N	0
H04	Auto-reset (Times)	0: Disable 1 to 10	1	Times	Y	0
H05	(Reset interval)	0.5 to 20.0	0.1	s	Y	5.0
H06	Cooling Fan ON/OFF Control	0: Disable (Always in operation) 1: Enable (ON/OFF controllable)	—	—	Y	0
H07	Acceleration/Deceleration Pattern	0: Linear 1: S-curve (Weak) 2: S-curve (Strong) 3: Curvilinear	—	—	Y	0
H08	Limiting the direction of the motor rotation	0: Disable 1: Enable (Reverse rotation inhibited) 2: Enable (Forward rotation inhibited)	—	—	Y	0
H09	Starting Mode (Auto search)	0: Disable 1: Enable (At restart after momentary power failure) 2: Enable (At restart after momentary power failure and at normal start)	—	—	Y	0
H11	Deceleration Mode	0: Normal deceleration 1: Coast-to-stop	—	—	Y	0
H12	Instantaneous Overcurrent Limiting (Mode selection)	0: Disable 1: Enable	—	—	Y	1
H13	Restart Mode after Momentary Power Failure (Restart time)	0.1 to 10.0	0.1	s	Y1Y2	Depending on the inverter capacity
H14	(Frequency fall rate)	0.00 : FSelected deceleration time 0.01 to 100.00 999: Follow the current limit command	0.01	Hz/s	Y	999
H15	(Allowable momentary power failure time)	0.0 to 30.0 999 : Automatically determined by inverter	0.1	s	Y	999
H26	Thermistor (Mode selection)	0: Disable 1: Enable (With PTC, the inverter immediately trips with OH4 displayed.) 0.00 to 5.00V 2: Enable (With PTC, the inverter issues output signal THM and continues to run.)	—	—	Y	0
H27	(Level)	0.00 to 5.00	0.01	V	Y	1.60
H28	Droop control	-60.0 to 0.0	0.1	Hz	Y	0.0
H30	Communications Link Function (Mode selection)	Frequency command Run command 0: F01/C30 F02 1: RS-485 F02 2: F01/C30 RS-485 3: RS-485 RS-485 4: RS-485 (option) F02 5: RS-485 (option) RS-485 6: F01/C30 RS-485 (option) 7: RS-485 RS-485 (option) 8: RS-485 (option) RS-485 (option)	—	—	Y	0
H42	Capacitance of DC Link Bus Capacitor	Indication for replacing DC link bus capacitor (0000 to FFFF: Hexadecimal)	1	—	N	—
H43	Cumulative Run Time of Cooling Fan	Indication of cumulative run time of cooling fan for replacement	—	—	N	—
H44	Startup Times of Motor 1	Indication of cumulative startup times	—	—	N	—
H45	Mock Alarm	0: Disable 1: Enable (Once a mock alarm occurs, the data automatically returns to 0.)	—	—	N	0
H47	Initial Capacitance of DC Link Bus Capacitor	Indication for replacing DC link bus capacitor (0000 to FFFF: Hexadecimal)	—	—	N	Set at factory shipping
H48	Cumulative Run Time of Capacitors on Printed Circuit Boards	Indication for replacing capacitors on printed circuit boards (0000 to FFFF: Hexadecimal). Resettable.	—	—	N	—
H49	Starting Mode (Delay time)	0.0 to 10.0	0.1	s	Y	0.0
H50	Non-linear V/f Pattern,1 (Frequency)	0.0 : Cancel 0.1 to 400.0	0.1	Hz	Y	0.0
H51	(Voltage)	0 to 240 : Output an AVR-controlled voltage (for 230 V class series) 0 to 500 : Output an AVR-controlled voltage (for 460 V class series)	1	V	Y2	0
H52	Non-linear V/f Pattern,2 (Frequency)	0.0 : Cancel 0.1 to 400.0	0.1	Hz	Y	0.0
H53	(Voltage)	0 to 240 : Output an AVR-controlled voltage (for 230 V class series) 0 to 500 : Output an AVR-controlled voltage (for 460 V class series)	1	V	Y2	0
H54	ACC/DEC time (Jogging operation)	0.00 to 3600 *ACC time and DEC time are common.	0.01	s	Y	6.00
H56	Deceleration Time for Forced Stop	0.00 to 3600	0.01	s	Y	6.00

●H codes: High Performance Functions

Func. Code	Name	Data setting range	Min.	Unit	Data copy ²	Default setting															
H61	UP/DOWN Control (Initial frequency setting)	0 : 0.00 1 : Last UP /DOWN command value on releasing run command	—	—	Y	1															
H63	Low Limiter (Mode selection)	0 : Limit by F16 (Frequency limiter: Low) and continue to run 1 : If the output frequency lowers less than the one limited by F16 (Frequency limiter: Low), decelerate to stop the motor.	—	—	Y	0															
H64	(Lower limiting frequency)	0.0 (Depends on F16 (Frequency limiter: Low)) 0.1 to 60.0	0.1	Hz	Y	1.6															
H68	Slip Compensation 1 (Operating conditions)	0 : Enable during ACC/DEC and enable at base frequency or above 1 : Disable during ACC/DEC and enable at base frequency or above 2 : Enable during ACC/DEC and disable at base frequency or above 3 : Disable during ACC/DEC and disable at base frequency or above	—	—	Y	0															
H69	Automatic Deceleration (Mode selection)	0 : Disable 2 : Enable (Canceled if actual deceleration time exceeds three times the one specified by F08/E11.) 4 : Enable (Not canceled if actual deceleration time exceeds three times the one specified by F08/E11.)	—	—	Y	0															
H70	Overload Prevention Control	0.00 : Follow deceleration time specified by F08/E11 0.01 to 100.0 999: Disable	0.01	Hz/s	Y	999															
H71	Deceleration Characteristics	0 : Disable 1 : Enable	—	—	Y	0															
H76	Torque Limiter (Frequency increment limit for braking)	0.0 to 400.0	0.1	Hz	Y	5.0															
H80	Output Current Fluctuation Damping Gain for Motor 1	0.00 to 0.40	0.01	—	Y	0.20															
H89 1	Reserved. *3																				
H90																					
H91	C1 Disconnection Detection Time (PID control feedback line)	0.0: Disable 0.1 to 60.0: Detection time	—	—		0.0															
H94	Cumulative Motor Run Time 1	Change or reset the cumulative data	—	—	N	—															
H95	DC Braking (Braking response mode)	0 : Slow 1 : Quick	—	—	Y	1															
H96	STOP Key Priority/ Start Check Function	<table border="1"> <thead> <tr> <th>Item \ Data</th> <th>0</th> <th>1</th> <th>2</th> <th>3</th> </tr> </thead> <tbody> <tr> <td>STOP key priority</td> <td>Disable</td> <td>Enable</td> <td>Disable</td> <td>Enable</td> </tr> <tr> <td>Start check function</td> <td>Disable</td> <td>Disable</td> <td>Enable</td> <td>Enable</td> </tr> </tbody> </table>	Item \ Data	0	1	2	3	STOP key priority	Disable	Enable	Disable	Enable	Start check function	Disable	Disable	Enable	Enable	—	—	Y	0
Item \ Data	0	1	2	3																	
STOP key priority	Disable	Enable	Disable	Enable																	
Start check function	Disable	Disable	Enable	Enable																	
H97	Clear Alarm Data	Setting H97 data to "1" clears alarm data and then returns to zero.	—	—	N	0															
H98	Protection/Maintenance Function (Mode selection)	0 to 31: Display data on the keypad's LED monitor in decimal format (In each bit, "0" for disabled, "1" for enabled.) Bit 0 : Lower the carrier frequency automatically Bit 1 : Detect input phase loss Bit 2 : Detect output phase loss Bit 3 : Select life judgment threshold of DC link bus capacitor Bit 4 : Judge the life of DC link bus capacitor	—	—	Y	19 (bit 4,1,0=1)															

●A codes: Motor 2 Parameters

Func. Code	Name	Data setting range	Min.	Unit	Data copy ²	Default setting
A01	Maximum Frequency 2	25.0 to 400.0	0.1	Hz	Y	60.0
A02	Base Frequency 2	25.0 to 400.0	0.1	Hz	Y	60.0
A03	Rated Voltage at Base Frequency 2	0: Output a voltage in proportion to input voltage 80 to 240: Output an AVR-controlled voltage (for 230 V class series) 160 to 500: Output an AVR-controlled voltage (for 460 V class series)	1	V	Y2	230 460
A04	Maximum output Voltage 2	80 to 240V: Output an AVR-controlled voltage (for 230 V class series) 160 to 500V: Output an AVR-controlled voltage (for 460 V class series)	1	V	Y2	230 460
A05	Torque Boost 2	0.0 to 20.0(percentage with respect to "A03: Rated Voltage at Base Frequency 2") Note: This setting takes effect when A13 = 0, 1, 3, or 4.	0.1	%	Y	Depending on the inverter capacity
A06	Electronic Thermal Overload Protection for Motor 2 (Select motor characteristics)	1 : For a general-purpose motor with shaft-driven cooling fan 2 : For an inverter-driven motor, non-ventilated motor, or motor with separately powered cooling fan	—	—	Y	1
A07	(Overload detection level)	0.00 : Disable 1 to 135% of the rated current (allowable continuous drive current) of the motor	0.01	A	Y1Y2	100% of the motor rated current
A08	(Thermal time constant)	0.5 to 75.0	0.1	min	Y	5.0
A09	DC (Braking starting frequency)	0.0 to 60.0 Hz	0.1	Hz	Y	0.0
A10	Braking 2 (Braking level)	0 to 100	1	%	Y	0
A11	(Braking time)	0.00 : Disable 0.01 to 30.00	0.01	s	Y	0.00
A12	Starting Frequency 2	0.1 to 60.0	0.1	Hz	Y	0.5
A13	Load Selection/ Auto Torque Boost / Auto Energy Saving Operation 2	0 : Variable torque load 1 : Constant torque load 2 : Auto-torque boost 3 : Auto-energy saving operation (Variable torque load during ACC/DEC) 4 : Auto-energy saving operation (Constant torque load during ACC/DEC) 5 : Auto-energy saving operation (Auto-torque boost during ACC/DEC)	—	—	Y	1
A14	Control Mode Selection 2	0 : V/f operation with slip compensation inactive 1 : Dynamic torque vector operation 2 : V/f operation with slip compensation active 3 : V/f operation with PG 4 : Dynamic torque vector operation with PG	—	—	Y	0

*1 When you make settings from the keypad, the incremental unit is restricted by the number of digits that the LED monitor can display.
(Example) If the setting range is from -200.00 to 200.00, the incremental unit is as follows:
"1" for -200 to -100, "0.1" for -99.9 to -10.0, "0.01" for -9.99 to -0.01, "0.01" for 0.00 to 99.99, and "0.1" for 100.0 to 200.0

*2 Symbols in the "Data copy" column
Y: Will be copied unconditionally.
Y1: Will not be copied if the rated capacity differs from the source inverter.
Y2: Will not be copied if the rated input voltage differs from the source inverter.
N: Will not be copied.

*3 Reserved for the maker. Do not set any data.
<Changing, validating, and saving function code data when the motor is running>
□: Impossible, □: Possible (Change data with ⏏️ keys and then save/validate it with ⏏️ key), □: Possible (Change and validate data with ⏏️ keys and then save it with ⏏️ key)

■ Functions Settings

● A codes: Motor 2 Parameters

Func. Code	Name	Data setting range	Min.	Unit	Data copy ^{*2}	Default setting
R15	Motor 2 (No. of poles)	2 to 22	2	Pole	Y1Y2	4
R16	(Rated capacity)	0.01 to 30.00 (where, P99 data is 0, 3, or 4.)	0.01	kW	Y1Y2	4
		0.01 to 30.00 (where, P99 data is 1.)	0.01	HP		
R17	(Rated current)	0.00 to 100.0	0.01	A	Y1Y2	Rated value of Fuji standard motor
R18	(Auto-tuning)	0 : Disable 1 : Enable (Tune %R1 and %X while the motor is stopped.) 2 : Enable (Tune %R1, %X and rated slip while the motor is stopped, and no-load current while running.)	—	—	N	0
R19	(ON-Line tuning)	0 : Disable 1 : Enable	—	—	Y	0
R20	(No-load current)	0.00 to 50.00	0.01	A	Y1Y2	Rated value of Fuji standard motor
R21	(%R1)	0.00 to 50.00	0.01	%	Y1Y2	Rated value of Fuji standard motor
R22	(%X)	0.00 to 50.00	0.01	%	Y1Y2	Rated value of Fuji standard motor
R23	(Slip compensation gain for driving)	0.0 to 200.0	0.01	%	Y	100.0
R24	(Slip compensation response time)	0.00 to 10.00	0.01	s	Y1Y2	0.50
R25	(Slip compensation gain for braking)	0.0 to 10.00	0.01	%	Y	100.0
R26	(Rated slip frequency)	0.00 to 15.00	0.01	Hz	Y1Y2	Rated value of Fuji standard motor
R39	Motor 2 Selection	0 : Motor characteristics 0 (Fuji standard motors, 8-series) 1 : Motor characteristics 1 (HP rating motors) 3 : Motor characteristics 3 (Fuji standard motors, 6-series) 4 : Other motors	—	—	Y1Y2	0
R40	Slip compensation 2 (Operating conditions)	0 : Enable during ACC/DEC and enable at base frequency or above 1 : Disable during ACC/DEC and enable at base frequency or above 2 : Enable during ACC/DEC and disable at base frequency or above 3 : Disable during ACC/DEC and disable at base frequency or above	—	—	Y	0
R41	Output Current Fluctuation Damping Gain for Motor 2	0.00 to 0.40	0.01	—	Y	0.20
R45	Cumulative Motor Run Time 2	Change or reset the cumulative data	—	—	N	—
R46	Startup Times of Motor 2	Indication of cumulative startup times	—	—	N	—

● J codes: Application Functions

Func. Code	Name	Data setting range	Min.	Unit	Data copy ^{*2}	Default setting
J01	PID Control (Mode selection)	0 : Disable 1 : Enable (Process control, normal operation) 2 : Enable (Process control, inverse operation) 3 : Enable (Dancer control)	—	—	Y	0
J02	(Remote command SV)	0 : UP/DOWN keys on keypad 1 : PID command 1 3 : Terminal command UP /DOWN control 4 : Command via communications link	—	—	Y	0
J03	P (Gain)	0.000 to 30.000 ^{*1}	0.001	Times	Y	0.100
J04	I (Integral time)	0.0 to 3600.0 ^{*1}	0.1	s	Y	0.0
J05	D (Differential time)	0.0 to 600.00 ^{*1}	0.01	s	Y	0.00
J06	(Feedback filter)	0.0 to 900.0	0.1	s	Y	0.5
J10	PID Control (Anti reset windup)	0 to 200	1	%	Y	200
J11	(Select alarm output)	0 : Absolute-value alarm 1 : Absolute-value alarm (with Hold) 2 : Absolute-value alarm (with Latch) 3 : Absolute-value alarm (with Hold and Latch) 4 : Deviation alarm 5 : Deviation alarm (with Hold) 6 : Deviation alarm (with Latch) 7 : Deviation alarm (with Hold and Latch)	—	—	Y	0
J12	(Upper level alarm (AH))	-100 to 100	1	%	Y	100
J13	(Lower level alarm (AL))	-100 to 100	1	%	Y	0
J18	(Upper limit of PID process output)	-150 to 150 999 : F Disable	1	%	Y	999
J19	(Lower limit of PID process output)	-150 to 150 999 : F Disable	1	%	Y	999
J56	(Speed command filter)	0.00 to 5.00	0.01	s	Y	0.10
J57	(Dancer reference position)	-100 to 100	1	%	Y	0
J58	(Detection width of Dancer position deviation)	0 : Disable switching PID constant 1 to 100	1	%	Y	0
J59	P (gain) 2	0.000 to 30.00 ^{*1}	0.001	times	Y	0.100
J60	I (Integration time) 2	0.0 to 3600.0 ^{*1}	0.1	s	Y	0.0
J61	D (Derivative time) 2	0.00 to 600.00 ^{*1}	0.01	s	Y	0.00
J62	(Selection PID control block) (PID control block Selection)	Bit 0 : PID output pole 0 = addition, 1 = subtraction Bit 1 : Select compensation of output ratio 0 = speed command, 1 = ratio	1	—	Y	0
J63	Overload stop (Detection value)	0 : Torque 1 : Current	—	—	Y	0
J64	(Detection level)	20 to 200	0.1	%	Y	100
J65	(Mode selection)	0 : Disable 1 : Decelerate to stop 2 : Coast to a stop 3 : Hit mechanical stop	—	—	Y	0
J66	(Operation condition)	0 : Enable at constant speed and during deceleration 1 : Enable at constant speed 2 : Enable anytime	—	—	Y	0
J67	(Timer)	0.00 to 600.00	0.01	s	Y	0
J68	Braking signal (Released current)	0 to 200	1	%	Y	100
J69	(Brake OFF frequency)	0.0 to 25.0	0.1	Hz	Y	1.0
J70	(Brake OFF timer)	0.0 to 5.0	0.1	s	Y	1.0
J71	(Brake ON frequency)	0.0 to 25.0	0.1	Hz	Y	1.0
J72	(Brake ON timer)	0.0 to 5.0	0.1	s	Y	1.0

● J codes: Application Functions

Func. Code	Name	Data setting range	Min.	Unit	Data copy ²	Default setting
J73	Position control (the start timer)	0.0 to 1000.0	0.1	s	Y	0.0
J74	(Start point: MSD)	-999 to 999	1	p	Y	0
J75	(Start point: LSD)	[P], 0 to 9999	1	p	Y	0
J76	(Position preset: MSD)	-999 to 999	1	p	Y	0
J77	(Position preset: LSD)	[P], 0 to 9999	1	p	Y	0
J78	(Creep speed switch point: MSD)	0 to 999	1	p	Y	0
J79	(Creep speed switch point: LSD)	0 to 9999	1	p	Y	0
J80	(Creep speed)	0 to 400	1	Hz	Y	0
J81	(Stopping position: MSD)	-999 to 999	1	p	Y	0
J82	(Stopping position: LSD)	0 to 9999	1	p	Y	0
J83	(Completion width)	0 to 9999	1	p	Y	0
J84	(End timer)	0.0 to 1000.0	0.1	s	Y	0.0
J85	(Coasting compensation)	0 to 9999	1	p	Y	0
J86	(Stopping position specifying method)	0, 1	—	—	Y	0
J87	(Position pre-set condition)	0, 1, 2	—	—	Y	0
J88	(Position detecting direction)	0, 1	—	—	Y	0
J90	Overload stopping, torque limit P (Gain)	0.000 to 2.000, 999	0.001	—	Y	999
J91	Function, torque limit I (Integral time)	0.001 to 9.999, 999	0.001	s	Y	999
J92	Current control level	50.0 to 150.0	0.1	%	Y	100.0

● y codes: Link Functions

Func. Code	Name	Data setting range	Min.	Unit	Data copy ²	Default setting
Y01	RS-485 Communication (Standard) (Station address)	1 to 255	1	—	Y	1
Y02	(Communications error processing)	0 : Immediately trip with alarm <i>E_rB</i> 1 : Trip with alarm <i>E_rB</i> after running for the period specified by timer y03 2 : Retry during the period specified by timer y13. If the retry fails, trip with alarm <i>E_rB</i> . If it succeeds, continue to run. 3 : Continue to run	—	—	Y	0
Y03	(Timer)	0.0 to 60.0	0.1	s	Y	2.0
Y04	(Baud rate)	0 : 2400 bps 1 : 4800 bps 2 : 9600 bps 3 : 19200 bps 4 : 38400 bps	—	—	Y	3
Y05	(Data length)	0 : 8 bits 1 : 7 bits	—	—	Y	0
Y06	(Parity check)	0 : None (2 stop bits for Modbus RTU) 1 : Even parity (1 stop bit for Modbus RTU) 2 : Odd parity (1 stop bit for Modbus RTU) 3 : None (1 stop bit for Modbus RTU)	—	—	Y	0
Y07	(Stop bits)	0 : 2 bits 1 : 1 bit	—	—	Y	0
Y08	(No-response error detection time)	0 : No detection 1 to 60	1	s	Y	0
Y09	(Response interval)	0.00 to 1.00	0.01	s	Y	0.01
Y10	(Protocol selection)	0 : Modbus RTU protocol 1 : FRENIC Loader protocol (SX protocol) 2 : Fuji general-purpose inverter protocol	—	—	Y	1
Y11	RS-485 Communication (Option) (Station address)	1 to 255	1	—	Y	1
Y12	(Communications error processing)	0 : Immediately trip with alarm <i>E_rP</i> 1 : Trip with alarm <i>E_rP</i> after running for the period specified by timer y13 2 : Retry during the period specified by timer y13. If the retry fails, trip with alarm <i>E_rP</i> . If it succeeds, continue to run. 3 : Continue to run	—	—	Y	0
Y13	(Timer)	0.0 to 60.0	0.1	s	Y	2.0
Y14	(Baud rate)	0 : 2400 bps 1 : 4800 bps 2 : 9600 bps 3 : 19200 bps 4 : 38400 bps	—	—	Y	3
Y15	(Data length)	0 : 8 bits 1 : 7 bits	—	—	Y	0
Y16	(Parity check)	0 : None (2 stop bits for Modbus RTU) 1 : Even parity (1 stop bit for Modbus RTU) 2 : Odd parity (1 stop bit for Modbus RTU) 3 : None (1 stop bit for Modbus RTU)	—	—	Y	0
Y17	(Stop bits)	0 : 2 bits 1 : 1 bit	—	—	Y	0
Y18	(No-response error detection time)	0 : No detection 1 to 60	1	s	Y	0
Y19	(Response interval)	0.00 to 1.00	0.01	s	Y	0.01
Y20	(Protocol selection)	0 : Modbus RTU protocol 2 : Fuji general-purpose inverter protocol	—	—	Y	0
Y98	Bus Link Function (Mode selection)	Frequency command 0 : Follow H30 data 1 : Via field bus option 2 : Follow H30 data 3 : Via field bus option	—	—	Y	0
Y99	Loader Link Function (Mode selection)	Frequency command 0 : Follow H30 and y98 data 1 : Via RS-485 link (Loader) 2 : Follow H30 and y98 data 3 : Via RS-485 link (Loader)	—	—	N	0

*1 When you make settings from the keypad, the incremental unit is restricted by the number of digits that the LED monitor can display.
(Example) If the setting range is from -200.00 to 200.00, the incremental unit is as follows to 99.99: "1" for -200 to -100, "0.1" for -99.9 to -10.0, "0.01" for -9.99 to -0.01, "0.01" for 0.00 to 99.99, and "0.1" for 100.0 to 200.0

*2 Symbols in the "Data copy" column
Y: Will be copied unconditionally.
Y1: Will not be copied if the rated capacity differs from the source inverter.

Y2: Will not be copied if the rated input voltage differs from the source inverter.
N: Will not be copied.

*3 Reserved for the maker. Do not set any data.

<Changing, validating, and saving function code data when the motor is running>
 Impossible, Possible (Change data with keys and then save/validate it with)
 Impossible, Possible (Change and validate data with keys and then save it with)

Functions Settings

o codes: Link Functions

Func. Code	Name	Data setting range	Min.	Unit	Data copy ^{*2}	Default setting
o01	Command/feedback input (Input form selection)	0, 1, 2, 10, 11, 12, 20, 21, 22	1	—	Y	0
o02	Speed control (P item)	0.01 to 200.00	0.01	—	Y	10.00
o03	(I item)	0.000 to 5.000	0.001	s	Y	0.100
o04	(Filter time constant)	0.000 to 5.000	0.001	s	Y	0.020
o05	(Pulse line input) (Encode pulse number)	20 to 3600	1	—	Y	1024
o06	(Filter time constant)	0.000 to 5.000	0.001	s	Y	0.005
o07	(Pulse compensation coefficient 1)	1 to 9999	1	—	Y	1
o08	(Pulse compensation coefficient 2)	1 to 9999	1	—	Y	1
o09	Feedback (Feedback input) (Encoder pulse number)	20 to 3600	1	—	Y	1024
o10	(Filter time constant)	0.000 to 5.000	0.001	s	Y	0.005
o11	(Pulse compensation coefficient 1)	1 to 9999	1	—	Y	1
o12	(Pulse compensation coefficient 2)	1 to 9999	1	—	Y	1
o13	Speed control (Output limiter)	0.00 to 100.00	0.01	%	Y	100.00
o14	Reserved *3	0.1	1	—	Y	0
o15	Reserved *3	0.1	1	—	Y	0
o16	Reserved *3	0 to 255	1	—	Y	0
o17	Excessive speed deviation (Level)	0 to 50	1	%	Y	10
o18	(Timer)	0.0 to 10.0	0.1	s	Y	0.5
o19	PG abnormal error selection	0, 1, 2	1	—	Y	2
o20	DIO option (DI mode selection)	0: 8 bit binary setting 1: 12 bit binary setting 4: BCD 3-digit setting 0 to 99.9 5: BCD 3-digit setting 0 to 999	—	—	Y	0
o21	(DO mode selection)	0: Output frequency (befor slip compensation) 1: Out put frequency (after slip compensation) 2: Output current 3: Output voltage 4: Output torque 5: Overload rate 6: Power consumption 7: PID feedback amount 9: DC link circuit voltage 13: Motor output 15: PID command (SV) 16: PID command (MV) 99: Individual signal output	—	—	Y	0
o27	Transmission error (Operation selection)	0 to 15	1	—	Y	0
o28	(Timer selection)	0.0 to 60.0	0.1	s	Y	0.0
o30	Bus setting parameter 1	0 to 255	1	—	Y	0
o31	Bus setting parameter 2	0 to 255	1	—	Y	0
o32	Bus setting parameter 3	0 to 255	1	—	Y	0
o33	Bus setting parameter 4	0 to 255	1	—	Y	0
o34	Bus setting parameter 5	0 to 255	1	—	Y	0
o35	Bus setting parameter 6	0 to 255	1	—	Y	0
o36	Bus setting parameter 7	0 to 255	1	—	Y	0
o37	Bus setting parameter 8	0 to 255	1	—	Y	0
o38	Bus setting parameter 9	0 to 255	1	—	Y	0
o39	Bus setting parameter 10	0 to 255	1	—	Y	0
o40	Writing function code allocation 1	0000H to FFFFH	1	—	Y	0000H
o41	Writing function code allocation 2	0000H to FFFFH	1	—	Y	0000H
o42	Writing function code allocation 3	0000H to FFFFH	1	—	Y	0000H
o43	Writing function code allocation 4	0000H to FFFFH	1	—	Y	0000H
o44	Writing function code allocation 5	0000H to FFFFH	1	—	Y	0000H
o45	Writing function code allocation 6	0000H to FFFFH	1	—	Y	0000H
o46	Writing function code allocation 7	0000H to FFFFH	1	—	Y	0000H
o47	Writing function code allocation 8	0000H to FFFFH	1	—	Y	0000H
o48	Read function code allocation 1	0000H to FFFFH	1	—	Y	0000H
o49	Read function code allocation 2	0000H to FFFFH	1	—	Y	0000H
o50	Read function code allocation 3	0000H to FFFFH	1	—	Y	0000H
o51	Read function code allocation 4	0000H to FFFFH	1	—	Y	0000H
o52	Read function code allocation 5	0000H to FFFFH	1	—	Y	0000H
o53	Read function code allocation 6	0000H to FFFFH	1	—	Y	0000H
o54	Read function code allocation 7	0000H to FFFFH	1	—	Y	0000H
o55	Read function code allocation 8	0000H to FFFFH	1	—	Y	0000H
o56	Read function code allocation 9	0000H to FFFFH	1	—	Y	0000H
o57	Read function code allocation 10	0000H to FFFFH	1	—	Y	0000H
o58	Read function code allocation 11	0000H to FFFFH	1	—	Y	0000H
o59	Read function code allocation 12	0000H to FFFFH	1	—	Y	0000H

*1 When you make settings from the keypad, the incremental unit is restricted by the number of digits that the LED monitor can display.
(Example) If the setting range is from -200.00 to 200.00, the incremental unit is as follows:
"1" for -200 to -100, "0.1" for -99.9 to -10.0, "0.01" for -9.99 to -0.01, "0.01" for 0.00 to 99.99, and "0.1" for 100.0 to 200.0

*2 Symbols in the "Data copy" column

Y: Will be copied unconditionally.

Y1: Will not be copied if the rated capacity differs from the source inverter.

Y2: Will not be copied if the rated input voltage differs from the source inverter.
N: Will not be copied.

*3 Reserved for the maker. Do not set any data.

<Changing, validating, and saving function code data when the motor is running>

☐: Impossible, ☐: Possible (Change data with ⏏⏏ keys and then save/validate it with ⏏ key), ☐: Possible (Change and validate data with ⏏⏏ keys and then save it with ⏏ key)

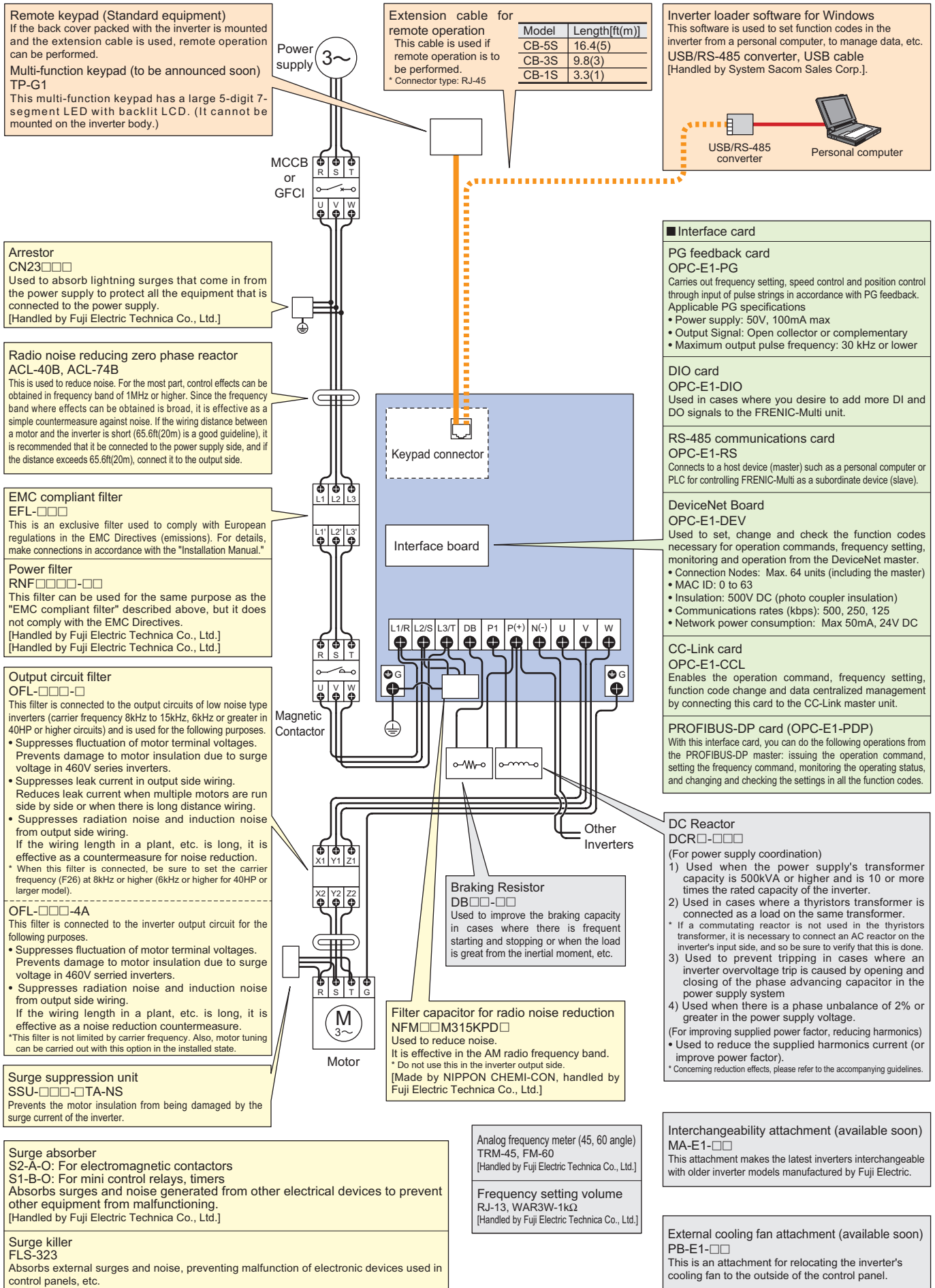

Options

Braking resistor	Type, specifications and external dimensions	[Unit: inch(mm)]
------------------	--	------------------

[Standard type] (DB□□□-2) (DB□□□-4)
 [10% ED type] (DB□□□-2C) (DB□□□-4C)

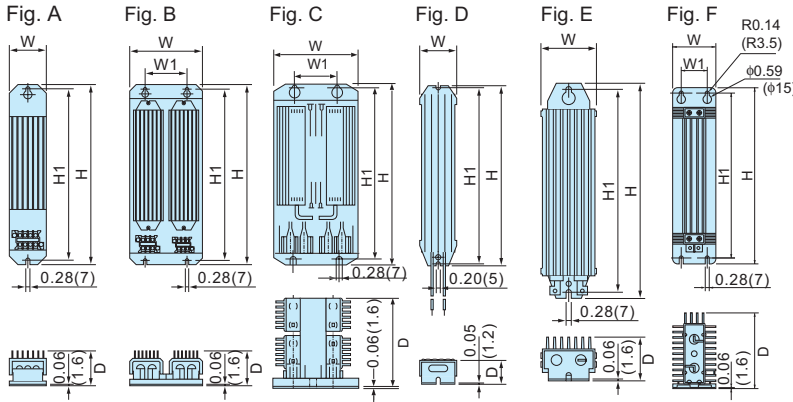

Standard type	Voltage		Fig	Dimensions [Unit: inch (mm)]				Mass [lbs(kg)]	
	230V series	460V series		W	W1	H	H1		D
DB0.75-2	DB0.75-4	A	2.52(64)	-	12.20(310)	11.61(295)	2.64(67)	2.9(1.3)	
DB2.2-2	—	A	2.99(76)	-	13.58(345)	13.07(332)	3.70(94)	4.4(2.0)	
—	DB2.2-4	A	2.52(64)	-	18.50(470)	17.91(455)	2.64(67)	4.4(2.0)	
DB3.7-2	—	A	2.99(76)	-	13.58(345)	13.07(332)	3.70(94)	4.4(2.0)	
—	DB3.7-4	A	2.52(64)	-	18.50(470)	17.91(455)	2.64(67)	3.7(1.7)	
DB5.5-2	—	B	3.54(90)	3.54(90)	17.72(450)	16.93(430)	2.66(67.5)	9.9(4.5)	
—	DB5.5-4	B	2.91(74)	2.91(74)	18.50(470)	17.91(455)	2.64(67)	9.9(4.5)	
DB7.5-2	—	B	3.54(90)	3.54(90)	15.35(390)	14.57(370)	3.54(90)	11(5.0)	
—	DB7.5-4	B	2.91(74)	2.91(74)	20.47(520)	19.49(495)	2.64(67)	11(5.0)	
DB11-2	—	C	5.59(142)	2.91(74)	16.93(430)	16.34(415)	6.30(160)	15(6.9)	
—	DB11-4	C	5.59(142)	2.91(74)	16.93(430)	16.34(415)	6.30(160)	15(6.9)	
DB15-2	—	C	5.59(142)	2.91(74)	16.93(430)	16.34(415)	6.30(160)	15(6.9)	
—	DB15-4	C	5.59(142)	2.91(74)	16.93(430)	16.34(415)	6.30(160)	15(6.9)	
10%ED type	DB0.75-2C	DB0.75-4C	D	1.69(43)	-	8.70(221)	8.46(215)	1.20(30.5)	1.1(0.5)
—	DB2.2-2C	DB2.2-4C	E	2.64(67)	-	7.40(188)	6.77(172)	2.17(55)	1.8(0.8)
—	DB3.7-2C	DB3.7-4C	E	2.64(67)	-	12.91(328)	12.28(312)	2.17(55)	3.5(1.6)
—	DB5.5-2C	DB5.5-4C	E	-	-	14.88(378)	14.25(362)	3.07(78)	6.4(2.9)
—	DB7.5-2C	DB7.5-4C	E	-	-	16.46(418)	15.83(402)	3.07(78)	7.3(3.3)
—	DB11-2C	DB11-4C	F	3.15(80)	1.97(50)	18.11(460)	17.32(440)	5.51(140)	9.5(4.3)
—	DB15-2C	DB15-4C	F	3.15(80)	1.97(50)	22.83(580)	17.32(440)	5.51(140)	12(5.6)

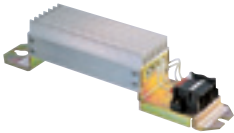

Braking resistor type	Power supply voltage	Inverter type	Type	Qty.	Resistance [Ω]	Max braking torque [%]		Continuous braking (100% torque conversion value)		Repetitive braking (Each cycle is less than 100[s])		
						50 [Hz]	60 [Hz]	Discharging capacity [HPs]	Braking time [s]	Average allowable loss [HP]	Duty cycle [%ED]	
						[lb-in (N·m)]	[lb-in (N·m)]					
Standard type	Three-phase 230V	FRNF50E1□-2U	DB0.75-2	1	100	35.6(4.02)	29.4(3.32)	9	45	0.06(0.044)	22	
		FRNF01E1□-2U	DB0.75-2	1	100	67.0(7.57)	55.3(6.25)	17	45	0.09(0.068)	18	
		FRNF02E1□-2U	DB2.2-2	1	40	133(15.0)	110(12.4)	34	30	0.10(0.075)	10	
		FRNF03E1□-2U	DB2.2-2	1	40	195(22.0)	161(18.2)	33	30	0.10(0.077)	7	
		FRNF05E1□-2U	DB3.7-2	1	33	328(37.1)	270(30.5)	37	20	0.12(0.093)	5	
		FRNF07E1□-2U	DB5.5-2	1	20	481(54.3)	358(40.5)	55	20	0.19(0.138)	5	
		FRNF10E1□-2U	DB7.5-2	1	15	658(74.4)	545(61.6)	37	10	0.25(0.188)	5	
		FRNF15E1□-2U	DB11-2	1	10	956(108)	792(89.5)	55	10	0.37(0.275)	5	
		FRNF20E1□-2U	DB15-2	1	8.6	1301(147)	1080(122)	75	10	0.50(0.375)	5	
	Three-phase 460V	FRNF50E1□-4U	DB0.75-4	1	200	35.6(4.02)	29.4(3.32)	9	45	0.06(0.044)	22	
		FRNF01E1□-4U	DB0.75-4	1	200	67.0(7.57)	55.3(6.25)	17	45	0.09(0.068)	18	
		FRNF02E1□-4U	DB2.2-4	1	160	133(15.0)	110(12.4)	34	30	0.10(0.075)	10	
		FRNF03E1□-4U	DB2.2-4	1	160	195(22.0)	161(18.2)	33	30	0.10(0.077)	7	
		FRNF05E1□-4U	DB3.7-4	1	130	328(37.1)	270(30.5)	37	20	0.12(0.093)	5	
		FRNF07E1□-4U	DB5.5-4	1	80	481(54.3)	398(45.0)	55	20	1.53(1.138)	5	
		FRNF10E1□-4U	DB7.5-4	1	60	651(73.6)	545(61.6)	38	10	0.25(0.188)	5	
		FRNF15E1□-4U	DB11-4	1	40	956(108)	792(89.5)	55	10	0.37(0.275)	5	
		FRNF20E1□-4U	DB15-4	1	34.4	1301(147)	1080(122)	75	10	0.50(0.375)	5	
Single-phase 230V	FRNF50E1□-7U	DB0.75-2	1	100	35.6(4.02)	29.4(3.32)	9	45	0.06(0.044)	22		
	FRNF01E1□-7U	DB0.75-2	1	100	67.0(7.57)	55.3(6.25)	17	45	0.09(0.068)	18		
	FRNF02E1□-7U	DB2.2-2	1	40	133(15.0)	110(12.4)	34	30	0.10(0.075)	10		
	FRNF03E1□-7U	DB2.2-2	1	40	195(22.0)	161(18.2)	33	30	0.10(0.077)	7		
	10%ED type	Three-phase 230V	FRNF50E1□-2U	DB0.75-2C	1	100	35.6(4.02)	29.4(3.32)	50	250	0.1(0.075)	37
			FRNF01E1□-2U	DB0.75-2C	1	100	67.0(7.57)	55.3(6.25)	50	133	0.1(0.075)	20
			FRNF02E1□-2U	DB2.2-2C	1	40	133(15.0)	110(12.4)	55	73	0.15(0.110)	14
			FRNF03E1□-2U	DB2.2-2C	1	40	195(22.0)	161(18.2)	50	50	0.15(0.110)	10
			FRNF05E1□-2U	DB3.7-2C	1	33	328(37.1)	270(30.5)	140	75	0.25(0.185)	10
FRNF07E1□-2U			DB5.5-2C	1	20	481(54.3)	359(40.5)	55	20	0.37(0.275)	10	
FRNF10E1□-2U			DB7.5-2C	1	15	659(74.4)	545(61.6)	37	10	0.50(0.375)	10	
FRNF15E1□-2U			DB11-2C	1	10	956(108)	792(89.5)	55	10	0.74(0.55)	10	
FRNF20E1□-2U			DB15-2C	1	8.6	1301(147)	1080(122)	75	10	1.01(0.75)	10	
Three-phase 460V		FRNF50E1□-4U	DB0.75-4C	1	200	35.6(4.02)	29.4(3.32)	50	250	6.71(5)	37	
		FRNF01E1□-4U	DB0.75-4C	1	200	67.0(7.57)	55.3(6.25)	50	133	6.71(5)	20	
		FRNF02E1□-4U	DB2.2-4C	1	160	133(15.0)	110(12.4)	55	73	0.15(0.110)	14	
		FRNF03E1□-4U	DB2.2-4C	1	160	195(22.0)	161(18.2)	55	50	0.15(0.110)	10	
		FRNF05E1□-4U	DB3.7-4C	1	130	328(37.1)	270(30.5)	140	75	0.25(0.185)	10	
		FRNF07E1□-4U	DB5.5-4C	1	80	481(54.3)	398(45.0)	55	20	0.37(0.275)	10	
		FRNF10E1□-4U	DB7.5-4C	1	60	651(73.5)	545(61.6)	38	10	0.50(0.375)	10	
		FRNF15E1□-4U	DB11-4C	1	40	956(108)	792(89.5)	55	10	0.74(0.55)	10	
		FRNF20E1□-4U	DB15-4C	1	34.4	1301(147)	1080(122)	75	10	1.01(0.75)	10	
Single-phase 230V	FRNF50E1□-7U	DB0.75-2C	1	100	35.6(4.02)	29.4(3.32)	50	250	0.10(0.075)	37		
	FRNF01E1□-7U	DB0.75-2C	1	100	67.0(7.57)	55.3(6.25)	50	133	0.10(0.075)	20		
	FRNF02E1□-7U	DB2.2-2C	1	40	133(15.0)	110(12.4)	55	73	0.15(0.110)	14		
—	FRNF03E1□-7U	DB2.2-2C	1	40	195(22.0)	161(18.2)	50	50	0.15(0.110)	10		

□: S or E S: standard E: EMC filter built-in type

[Compact type] (TK80W120Ω)

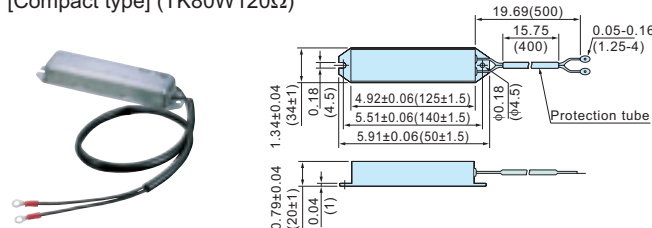

Power source voltage	Type	TK80W120Ω				
		Resistance	Capacity [HP]			
Three-phase 230V	Resistance	120				
	Capacity [HP]	0.11				
	Resistance [Ω]	120				
	Applicable inverter	FRNF50E1□-2U	FRNF01E1□-2U	FRNF02E1□-2U	FRNF03E1□-2U	FRNF05E1□-2U
	Applied motor output [HP]	1/2	1	2	3	5
	Average braking torque [%]	150	130	100	65	45
Allowable limits	Allowable duty cycle [%]	15	5	5	5	5
Continuous allowable braking time		15s	15s	10s	10s	10s

NOTE: This resistor is not applicable to three-phase 460V series and single-phase 230V series.

DC REACTOR

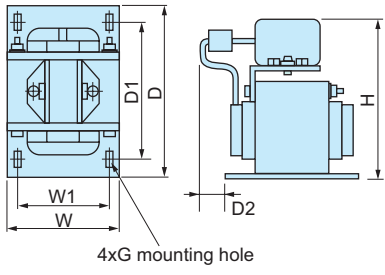

Power supply voltage	Applicable motor rating [HP]	Inverter type	REACTOR type	Dimensions Unit: inch (mm)							Mass [lbs (kg)]	
				W	W1	D	D1	D2	H	Mounting hole		
Three-phase 230V	1/8	FRNF12E1□-2U	DCR2-0.2	2.60(66)	2.20(56)	3.54(90)	2.83(72)	0.20(5)	3.70(94)	0.20x0.31(5.2x8)	M4	1.8(0.8)
	1/4	FRNF25E1□-2U										
	1/2	FRNF50E1□-2U	DCR2-0.4	2.60(66)	2.20(56)	3.54(90)	2.83(72)	0.59(15)	3.70(94)	0.20x0.31(5.2x8)	M4	2.2(1.0)
	1	FRN001E1□-2U	DCR2-0.75	2.60(66)	2.20(56)	3.54(90)	2.83(72)	0.79(20)	3.70(94)	0.20x0.31(5.2x8)	M4	3.1(1.4)
	2	FRN002E1□-2U	DCR2-1.5	2.60(66)	2.20(56)	3.54(90)	2.83(72)	0.79(20)	3.70(94)	0.20x0.31(5.2x8)	M4	3.5(1.6)
	3	FRN003E1S-2U	DCR2-2.2	3.39(86)	2.80(71)	3.94(100)	3.15(80)	0.39(10)	4.33(110)	0.24x0.43(6x11)	M4	4.0(1.8)
	5	FRN005E1□-2U	DCR2-3.7	3.39(86)	2.80(71)	3.94(100)	3.15(80)	0.79(20)	4.33(110)	0.24x0.43(6x11)	M4	5.7(2.6)
	7.5	FRN007E1□-2U	DCR2-5.5	4.37(111)	3.74(95)	3.94(100)	3.15(80)	0.79(20)	5.12(130)	0.24x0.43(6x11)	M5	7.9(3.6)
	10	FRN010E1□-2U	DCR2-7.5	4.37(111)	3.74(95)	3.94(100)	3.15(80)	0.91(23)	5.12(130)	0.28x0.43(7x11)	M5	8.4(3.8)
	15	FRN015E1□-2U	DCR2-11	4.37(111)	3.74(95)	3.94(100)	3.15(80)	0.94(24)	5.39(137)	0.28x0.43(7x11)	M5	9.5(4.3)
20	FRN020E1□-2U	DCR2-15	5.75(146)	4.88(124)	4.72(120)	3.78(96)	0.59(15)	7.09(180)	0.28x0.43(7x11)	M6	13(5.9)	
Three-phase 460V	1/2	FRNF50E1□-4U	DCR4-0.4	2.60(66)	2.20(56)	3.54(90)	2.83(72)	0.59(15)	3.70(94)	0.20x0.31(5.2x8)	M4	2.2(1.0)
	1	FRN001E1□-4U	DCR4-0.75	2.60(66)	2.20(56)	3.54(90)	2.83(72)	0.79(20)	3.70(94)	0.20x0.31(5.2x8)	M4	3.1(1.4)
	2	FRN002E1□-4U	DCR4-1.5	2.60(66)	2.20(56)	3.54(90)	2.83(72)	0.79(20)	3.70(94)	0.20x0.31(5.2x8)	M4	3.5(1.6)
	3	FRN003E1□-4U	DCR4-2.2	2.60(66)	2.80(71)	3.94(100)	3.15(80)	0.59(15)	4.33(110)	0.24x0.35(6x9)	M4	4.4(2.0)
	5	FRN005E1□-4U	DCR4-3.7	3.39(86)	2.80(71)	3.94(100)	3.15(80)	0.79(20)	4.33(110)	0.24x0.35(6x9)	M4	5.7(2.6)
	7.5	FRN007E1□-4U	DCR4-5.5	3.39(86)	2.80(71)	3.94(100)	3.15(80)	0.79(20)	4.33(110)	0.24x0.35(6x9)	M4	5.7(2.6)
	10	FRN010E1□-4U	DCR4-7.5	4.37(111)	3.74(95)	3.94(100)	3.15(80)	0.94(24)	5.12(130)	0.28x0.43(7x11)	M5	9.3(4.2)
	15	FRN015E1□-4U	DCR4-11	4.37(111)	3.74(95)	3.94(100)	3.15(80)	0.94(24)	5.12(130)	0.28x0.43(7x11)	M5	9.5(4.3)
Single-phase 230V	1/8	FRNF12E1□-7U	DCR2-0.2	2.60(66)	2.20(56)	3.54(90)	2.83(72)	0.20(5)	3.70(94)	0.20x0.31(5.2x8)	M4	1.8(0.8)
	1/4	FRNF25E1□-7U	DCR2-0.4	2.60(66)	2.20(56)	3.54(90)	2.83(72)	0.59(15)	3.70(94)	0.20x0.31(5.2x8)	M4	2.2(1.0)
	1/2	FRNF50E1□-7U	DCR2-0.75	2.60(66)	2.20(56)	3.54(90)	2.83(72)	0.79(20)	3.70(94)	0.20x0.31(5.2x8)	M4	3.1(1.4)
	1	FRN001E1□-7U	DCR2-1.5	2.60(66)	2.20(56)	3.54(90)	2.83(72)	0.79(20)	3.70(94)	0.20x0.31(5.2x8)	M4	3.5(1.6)
	2	FRN002E1□-7U	DCR2-2.2	3.39(86)	2.80(71)	3.94(100)	3.15(80)	0.39(10)	4.33(110)	0.24x0.43(6x11)	M4	4.0(1.8)
	3	FRN003E1□-7U	DCR2-3.7	3.39(86)	2.80(71)	3.94(100)	3.15(80)	0.79(20)	4.33(110)	0.24x0.43(6x11)	M4	5.7(2.6)

The code in □ represents followings; S: standard model, E: EMC filter built-in type

Multi-function keypad (TP-G1)

Connection with FRENIC-Multi using an extension cable for remote operation (optional) enables remote operation, function code data setting, monitoring, etc. from the keypad keys and panel. The keypad is equipped with an LCD panel (with backlight) and the copy function (for three inverter data).

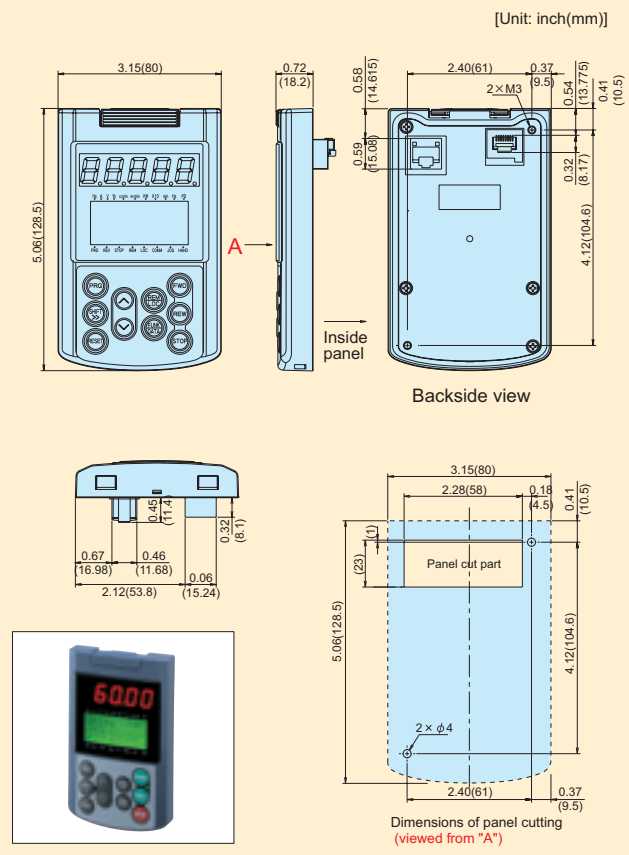

Extension cable for remote operation(CB-□S)

This is used to connect the inverter and the remote keypad.

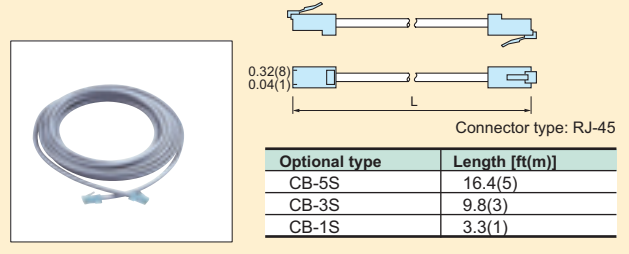

Options

Interface card

RS-485 communication card (OPC-F1-RS) Built-in type

Connection with a host (master) device such as PC or PLC allows you to control FRENIC-Multi as a subordinate (slave) device. (The card is added to the RS-485 communication devices for FRENIC-Multi.)

NOTE: This option card cannot be connected with the keypad or a support loader.

- Number of connectable devices: 1 host device and 31 inverters
- Number of ports: 2 ports
- Electric specifications: EIA RS-485
- Synchronization method: Start/stop
- Communication method: Half-duplex
- Transmission speed (bps): 2400, 4800, 9600, 19200 and 38400
- Maximum communication distance: 1600ft(500m)
- Terminating resistor: Built-in

PG interface card (OPC-E1-PG) for 5V Built-in type

When this card is built in the inverter, positioning accuracy will improve, resulting in reduced positioning time and improved measuring accuracy by the measuring instrument.

PG interface card (OPC-E1-PG3) for 12V Built-in type

Incorporating the interface card in the inverter permits accurate speed control and position control. The interface card can be used simultaneously with the communication bus for FRENIC-Multi series, optional DeviceNet card (OPC-E1-DEV), CC-Link card (OPC-E1-CCL), and PROFIBUS-DP card (OPC-E1-PDP).

DeviceNet card (OPC-E1-DEV) Front installation type

Connection with the DeviceNet master unit permits application to the system that requires operation commands and frequency settings.

DIO card (OPC-E1-DIO) Front installation type

This card allows frequency setting or status monitoring by exchanging digital signal data with the host controller.

SY card (synchronized operation) NOTE2) Built-in type

Using this card allows synchronized operation of the two motors having a pulse generator (PG).

PROFIBUS-DP card (OPC-E1-PDP) Front installation type

Connection with the PROFIBUS-DP card permits application to the system that requires operation commands and frequency settings.

Note1) An external power supply of 24V is needed to use a separately sold option card.

Note2) The inverter that can be used with the SY card includes special specifications. When ordering the SY card, please order together with the inverter in a set.

Front installation type External dimensions

- OPC-E1-CCL, OPC-E1-DEV

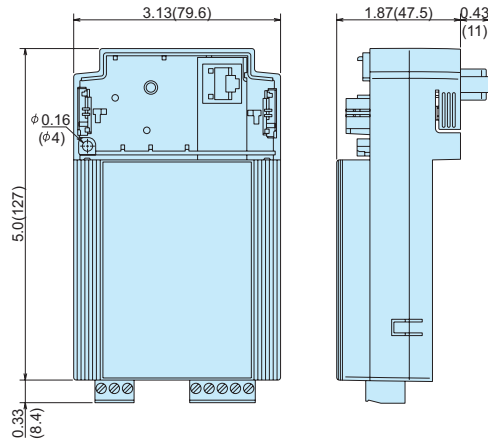

- OPC-E1-DIO

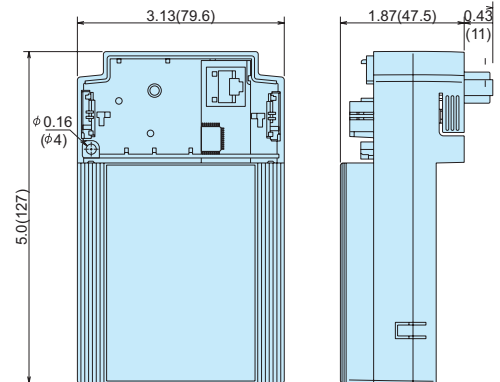

[Unit: inch(mm)]

External cooling attachment

External cooling attachment (PB-E1-7.5/PB-F1-15)

This attachment allows installation of the inverter heat sink outside the panel. With this attachment, it is possible to improve the cooling effect and to make the panel more compact.

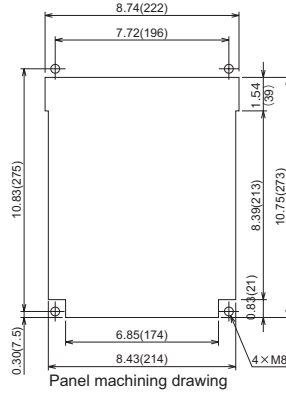
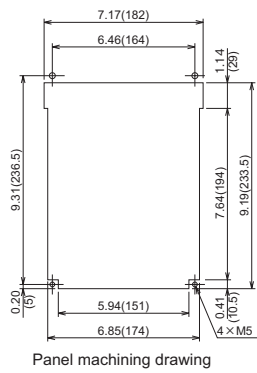
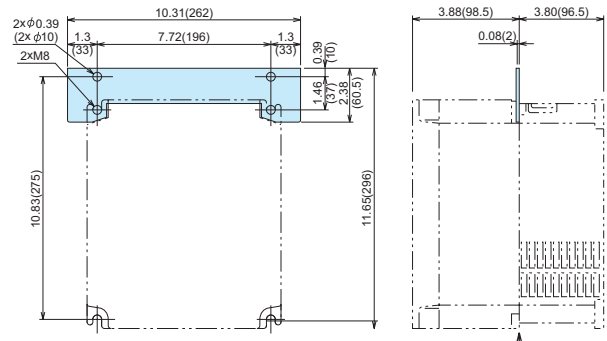
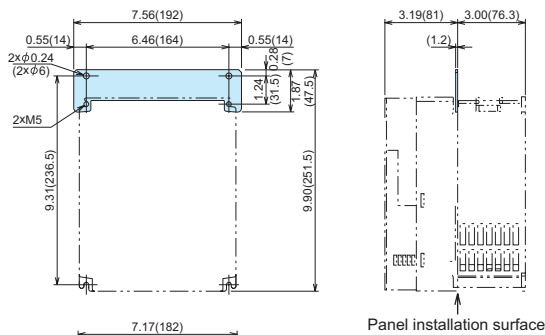

Optional type	Applicable inverter type
PB-E1-7.5	FRN007E1S-2/4U ∩ FRN010E1S-2/4U

Optional type	Applicable inverter type
PB-F1-15	FRN015E1S-2/4U ∩ FRN020E1S-2/4U

Compatible attachment

Compatible attachment (MA-E1-□□)

This attachment allows replacing our previous model with the new one without machining.

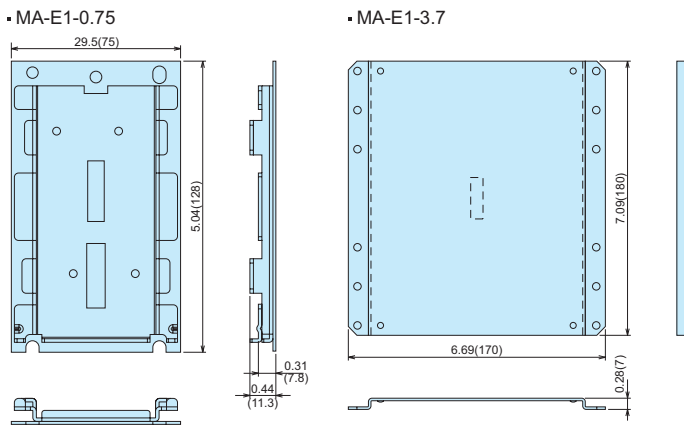

Optional type	Applicable inverter type	Previous inverter type
MA-E1-0.75	FRNF12E1S-2U	FVR0.1E11S-2
	FRNF25E1S-2U	FVR0.2E11S-2
	FRNF50E1S-2U	FVR0.4E11S-2
	FRN001E1S-2U	FVR0.75E11S-2
	FRNF12E1S-7U	FVR0.1E11S-7
	FRNF25E1S-7U	FVR0.2E11S-7
MA-E1-3.7	FRNF50E1S-7U	FVR0.4E11S-7
	FRN005E1S-2U	FVR3.7E11S-2
	FRN005E1S-4U	FVR3.7E11S-4
	FRN003E1S-7U	FVR2.2E11S-7

*The table below shows the previous and new inverters with are compatible and do not need attachment for replacement.

Applicable inverter type	Previous inverter type
FRN002E1S-2U	FVR1.5E11S-2
FRN003E1S-2U	FVR2.2E11S-2
FRNF50E1S-4U	FVR0.4E11S-4
FRN001E1S-4U	FVR0.75E11S-4
FRN002E1S-4U	FVR1.5E11S-4
FRN003E1S-4U	FVR2.2E11S-4
FRN002E1S-7U	FVR1.5E11S-7
FRN003E1S-7U	FVR2.2E11S-7
FRN007E1S-2U	FVR5.5E11S-2
FRN007E1S-4U	FVR5.5E11S-4
FRN010E1S-2U	FVR7.5E11S-2
FRN010E1S-4U	FVR7.5E11S-4

Options

Devices requiring wiring

Power supply voltage	Applicable motor rating (HP)	Inverter type	MCCB, GFCI rated current (A)		Magnetic contactor (MC)			Recommended cable size (mm ²) *1							
			With DCR	Without DCR	Input circuit		Output circuit	Main power input (L1/R, L2/S, L3/T)		Inverter output [U, V, W]	DC Reactor [P1, P (+)]	DC Reactor [P (+), DB]	For control circuit	For connection with Inverter [⊕G]	
					With DCR	Without DCR		With DCR	Without DCR						With DCR
Three-phase 230V	1/8	FRNF12E1□-2U	5	5	SC-05	SC-05	SC-05	2.0	2.0	2.0	2.0	2.0	0.75 to 1.25	2.0	
	1/4	FRNF25E1□-2U						2.0	2.0	2.0	2.0	2.0			
	1/2	FRNF50E1□-2U						2.0	2.0	2.0	2.0	2.0			
	1	FRN001E1□-2U	10	10				2.0	2.0	2.0	2.0	2.0			
	2	FRN002E1□-2U		15				2.0	2.0	2.0	2.0	2.0			
	3	FRN003E1□-2U		20				2.0	2.0	2.0	2.0	2.0			
	5	FRN005E1□-2U	20	30	SC-4-0	2.0	2.0	2.0	2.0	2.0					
	7.5	FRN007E1□-2U	30	50	SC-4-0	SC-5-1	SC-4-0	2.0	3.5	3.5	3.5	2.0			3.5
	10	FRN010E1□-2U	40	75	SC-5-1	SC-N1	SC-5-1	3.5	5.5	3.5	5.5	2.0			5.5
	15	FRN015E1□-2U	50	100	SC-N1	SC-N2S	SC-N1	5.5	14.0	8.0	8.0	2.0			8.0
20	FRN020E1□-2U	75	125	SC-N2	SC-N3	SC-N2	14.0	22.0	14.0	14.0	2.0	8.0			
Three-phase 460V	1/2	FRNF50E1□-4U	5	5	SC-05	SC-05	SC-05	2.0	2.0	2.0	2.0	2.0	0.75 to 1.25	2.0	
	1	FRN001E1□-4U						2.0	2.0	2.0	2.0	2.0			
	2	FRN002E1□-4U						10	10	2.0	2.0	2.0			2.0
	3	FRN003E1□-4U							15	2.0	2.0	2.0			2.0
	5	FRN005E1□-4U	10	20				2.0	2.0	2.0	2.0	2.0			
	7.5	FRN007E1□-4U	15	30				2.0	2.0	2.0	2.0	2.0			
	10	FRN010E1□-4U	20	40	SC-4-0	2.0	2.0	2.0	2.0	2.0					
	15	FRN015E1□-4U	30	50	SC-4-0	SC-N1	SC-4-0	2.0	3.5	2.0	3.5	2.0			3.5
20	FRN020E1□-4U	40	60	SC-5-1	SC-N1	SC-5-1	3.5	5.5	3.5	5.5	2.0				
Single-phase 230V	1/8	FRNF12E1□-7U	5	5	SC-05	SC-05	SC-05	2.0	2.0	2.0	2.0	2.0	0.75 to 1.25	2.0	
	1/4	FRNF25E1□-7U						2.0	2.0	2.0	2.0	2.0			
	1/2	FRNF50E1□-7U						10	10	2.0	2.0	2.0			2.0
	1	FRN001E1□-7U	15	2.0					2.0	2.0	2.0	2.0			
	2	FRN002E1□-7U	20	2.0					2.0	2.0	2.0	2.0			
	3	FRN003E1□-7U	20	30				SC-5-1	2.0	3.5	2.0	2.0			2.0

The code in □ represents followings; S: standard model, E: EMC filter built-in type

Note1) An external power supply of 24V is needed to use a separately sold option card.

Note2) The inverter that can be used with the SY card includes special specifications. When ordering the SY card, please order together with the inverter in a set.

• The frame and series of the MCCB and GFCI models vary according to the transformer capacity and so on of the equipment. Choose the optimum ones according to the catalog and technical data of the circuit breaker and others.

• Choose the optimum rated sensitive current of the ELCB according to technical data, too. The rated currents of the MCCB and GFCI specified in this table indicate those of SA□B□ and SA□R□ models.

• Description in the above table may vary for different ambient temperatures, power supply voltages or other conditions.

*1: Use crimp terminals equipped with insulation sheath or those equipped with an insulation tube or the like.

The cable to be used is 600V-insulated cable with an allowable temperature of 75°C(167°F). The ambient temperature is assumed to be 50°C(122°F).

To all our customers who purchase Fuji Electric FA Components & Systems' products:

Please take the following items into consideration when placing your order.

When requesting an estimate and placing your orders for the products included in these materials, please be aware that any items such as specifications which are not specifically mentioned in the contract, catalog, specifications or other materials will be as mentioned below.

In addition, the products included in these materials are limited in the use they are put to and the place where they can be used, etc., and may require periodic inspection. Please confirm these points with your sales representative or directly with this company.

Furthermore, regarding purchased products and delivered products, we request that you take adequate consideration of the necessity of rapid receiving inspections and of product management and maintenance even before receiving your products.

1. Free of Charge Warranty Period and Warranty Range

1-1 Free of charge warranty period

- (1) The product warranty period is "1 year from the date of purchase" or 24 months from the manufacturing date imprinted on the name place, whichever date is earlier.
- (2) However, in cases where the use environment, conditions of use, use frequency and times used, etc., have an effect on product life, this warranty period may not apply.
- (3) Furthermore, the warranty period for parts restored by Fuji Electric's Service Department is "6 months from the date that repairs are completed."

1-2 Warranty range

- (1) In the event that breakdown occurs during the product's warranty period which is the responsibility of Fuji Electric, Fuji Electric will replace or repair the part of the product that has broken down free of charge at the place where the product was purchased or where it was delivered. However, if the following cases are applicable, the terms of this warranty may not apply.
 - 1) The breakdown was caused by inappropriate conditions, environment, handling or use methods, etc. which are not specified in the catalog, operation manual, specifications or other relevant documents.
 - 2) The breakdown was caused by the product other than the purchased or delivered Fuji's product.
 - 3) The breakdown was caused by the product other than Fuji's product, such as the customer's equipment or software design, etc.
 - 4) Concerning the Fuji's programmable products, the breakdown was caused by a program other than a program supplied by this company, or the results from using such a program.
 - 5) The breakdown was caused by modifications or repairs affected by a party other than Fuji Electric.
 - 6) The breakdown was caused by improper maintenance or replacement using consumables, etc. specified in the operation manual or catalog, etc.
 - 7) The breakdown was caused by a chemical or technical problem that was not foreseen when making practical application of the product at the time it was purchased or delivered.
 - 8) The product was not used in the manner the product was originally intended to be used.
 - 9) The breakdown was caused by a reason which is not this company's responsibility, such as lightning or other disaster.
- (2) Furthermore, the warranty specified herein shall be limited to the purchased or delivered product alone.
- (3) The upper limit for the warranty range shall be as specified in item (1) above and any damages (damage to or loss of machinery or equipment, or lost profits from the same, etc.) consequent to or resulting from breakdown of the purchased or delivered product shall be excluded from coverage by this warranty.

1-3. Trouble diagnosis

As a rule, the customer is requested to carry out a preliminary trouble diagnosis. However, at the customer's request, this company or its service network can perform the trouble diagnosis on a chargeable basis. In this case, the customer is asked to assume the burden for charges levied in accordance with this company's fee schedule.

2. Exclusion of Liability for Loss of Opportunity, etc.

Regardless of whether a breakdown occurs during or after the free of charge warranty period, this company shall not be liable for any loss of opportunity, loss of profits, or damages arising from special circumstances, secondary damages, accident compensation to another company, or damages to products other than this company's products, whether foreseen or not by this company, which this company is not be responsible for causing.

3. Repair Period after Production Stop, Spare Parts Supply Period (Holding Period)

Concerning models (products) which have gone out of production, this company will perform repairs for a period of 7 years after production stop, counting from the month and year when the production stop occurs. In addition, we will continue to supply the spare parts required for repairs for a period of 7 years, counting from the month and year when the production stop occurs. However, if it is estimated that the life cycle of certain electronic and other parts is short and it will be difficult to procure or produce those parts, there may be cases where it is difficult to provide repairs or supply spare parts even within this 7-year period. For details, please confirm at our company's business office or our service office.

4. Transfer Rights

In the case of standard products which do not include settings or adjustments in an application program, the products shall be transported to and transferred to the customer and this company shall not be responsible for local adjustments or trial operation.

5. Service Contents

The cost of purchased and delivered products does not include the cost of dispatching engineers or service costs. Depending on the request, these can be discussed separately.

6. Applicable Scope of Service

Above contents shall be assumed to apply to transactions and use of the country where you purchased the products. Consult the local supplier or Fuji for the detail separately.



MEMO

MEMO



NOTES

When running general-purpose motors

• Driving a 460V general-purpose motor

When driving a 400V general-purpose motor with an inverter using extremely long cables, damage to the insulation of the motor may occur. Use an output circuit filter (OFL) if necessary after checking with the motor manufacturer. Fuji's motors do not require the use of output circuit filters because of their reinforced insulation.

• Torque characteristics and temperature rise

When the inverter is used to run a general-purpose motor, the temperature of the motor becomes higher than when it is operated using a commercial power supply. In the low-speed range, the cooling effect will be weakened, so decrease the output torque of the motor. If constant torque is required in the low-speed range, use a Fuji inverter motor or a motor equipped with an externally powered ventilating fan.

• Vibration

When the motor is mounted to a machine, resonance may be caused by the natural frequencies, including that of the machine. Operation of a 2-pole motor at 60Hz or more may cause abnormal vibration.

* Study use of tier coupling or dampening rubber.

* It is also recommended to use the inverter jump frequency control to avoid resonance points.

• Noise

When an inverter is used with a general-purpose motor, the motor noise level is higher than that with a commercial power supply. To reduce noise, raise carrier frequency of the inverter. High-speed operation at 60Hz or more can also result in more noise.

When running special motors

• High-speed motors

When driving a high-speed motor while setting the frequency higher than 120Hz, test the combination with another motor to confirm the safety of high-speed motors.

• Explosion-proof motors

When driving an explosion-proof motor with an inverter, use a combination of a motor and an inverter that has been approved in advance.

• Submersible motors and pumps

These motors have a larger rated current than general-purpose motors. Select an inverter whose rated output current is greater than that of the motor.

These motors differ from general-purpose motors in thermal characteristics. Set a low value in the thermal time constant of the motor when setting the electronic thermal facility.

• Brake motors

For motors equipped with parallel-connected brakes, their braking power must be supplied from the primary circuit (commercial power supply). If the brake power is connected to the inverter power output circuit (secondary circuit) by mistake, problems may occur.

Do not use inverters for driving motors equipped with series-connected brakes.

• Geared motors

If the power transmission mechanism uses an oil-

lubricated gearbox or speed changer/reducer, then continuous motor operation at low speed may cause poor lubrication. Avoid such operation.

• Synchronous motors

It is necessary to use software suitable for this motor type. Contact Fuji for details.

• Single-phase motors

Single-phase motors are not suitable for inverter-driven variable speed operation. Use three-phase motors.

* Even if a single-phase power supply is available, use a three-phase motor as the inverter provides three-phase output.

Environmental conditions

• Installation location

Use the inverter in a location with an ambient temperature range of -10 to 50°C (14 to 122°F).

The inverter and braking resistor surfaces become hot under certain operating conditions. Install the inverter on nonflammable material such as metal.

Ensure that the installation location meets the environmental conditions specified in "Environment" in inverter specifications.

Combination with peripheral devices

• Installing a molded case circuit breaker (MCCB)

Install a recommended molded case circuit breaker (MCCB) or a ground-fault circuit interrupter (GFCI) in the primary circuit of each inverter to protect the wiring. Ensure that the circuit breaker capacity is equivalent to or lower than the recommended capacity.

• Installing a magnetic contactor (MC) in the output (secondary) circuit

If a magnetic contactor (MC) is mounted in the inverter's secondary circuit for switching the motor to commercial power or for any other purpose, ensure that both the inverter and the motor are fully stopped before you turn the MC on or off. Remove the surge killer integrated with the MC.

• Installing a magnetic contactor (MC) in the input (primary) circuit

Do not turn the magnetic contactor (MC) in the primary circuit on or off more than once an hour as an inverter fault may result. If frequent starts or stops are required during motor operation, use FWD/REV signals.

• Protecting the motor

The electronic thermal facility of the inverter can protect the motor. The operation level and the motor type (general-purpose motor, inverter motor) should be set. For high-speed motors or water-cooled motors, set a small value for the thermal time constant to protect the motor.

If you connect the motor thermal relay to the motor with a long cable, a high-frequency current may flow into the wiring stray capacitance. This may cause the relay to trip at a current lower than the set value for the thermal relay. If this happens, lower the carrier frequency or use the output circuit filter (OFL).

• Discontinuance of power-factor correcting capacitor

Do not mount power factor correcting capacitors in the inverter (primary) circuit. (Use the DC REACTOR to improve the inverter power factor.) Do

not use power factor correcting capacitors in the inverter output circuit (secondary). An overcurrent trip will occur, disabling motor operation.

• Discontinuance of surge killer

Do not mount surge killers in the inverter output (secondary) circuit.

• Reducing noise

Use of a filter and shielded wires are typical measures against noise to ensure that EMC Directives are met.

• Measures against surge currents

If an overvoltage trip occurs while the inverter is stopped or operated under a light load, it is assumed that the surge current is generated by open/close of the phase-advancing capacitor in the power system.

We recommend connecting a DC REACTOR to the inverter.

• Megger test

When checking the insulation resistance of the inverter, use a 500V megger and follow the instructions contained in the Instruction Manual.

Wiring

• Wiring distance of control circuit

When performing remote operation, use the twisted shield wire and limit the distance between the inverter and the control box to 65.6ft(20m).

• Wiring length between inverter and motor

If long wiring is used between the inverter and the motor, the inverter will overheat or trip as a result of overcurrent (high-frequency current flowing into the stray capacitance) in the wires connected to the phases. Ensure that the wiring is shorter than 164ft(50m). If this length must be exceeded, lower the carrier frequency or mount an output circuit filter (OFL).

• Wiring size

Select cables with a sufficient capacity by referring to the current value or recommended wire size.

• Wiring type

Do not use multicore cables that are normally used for connecting several inverters and motors.

• Grounding

Securely ground the inverter using the grounding terminal.

Selecting inverter capacity

• Driving general-purpose motor

Select an inverter according to the applicable motor ratings listed in the standard specifications table for the inverter. When high starting torque is required or quick acceleration or deceleration is required, select an inverter with a capacity one size greater than the standard.

• Driving special motors

Select an inverter that meets the following condition: Inverter rated current > Motor rated current.

Transportation and storage

When transporting or storing inverters, follow the procedures and select locations that meet the environmental conditions that agree with the inverter specifications.

Fuji Electric FA Components & Systems Co., Ltd. Fuji Electric Corp. of America

47520 Westinghouse Drive Fremont, CA 94539, U.S.A.

Tel.+1-510-440-1060 Fax.+1-510-440-1063

<http://www.fujielectric.com>

Printed on 100% recycled paper